



CITY OF SACRAMENTO  
CALIFORNIA

NEIGHBORHOODS, PLANNING  
AND DEVELOPMENT SERVICES DEPARTMENT

1231 I STREET  
ROOM 200  
SACRAMENTO, CA  
95814-2998

**PLANNING DIRECTOR'S SPECIAL PERMIT  
FOR SINGLE FAMILY RESIDENTIAL IN A PUD**

**FILE:** P99-071

**PREVIOUS FILE NUMBER(S):** P96-058

**PROJECT NAME:** Renaissance Homes in Northpointe Park - Village 12

**ASSESSOR'S PARCEL NUMBER(S):** Various

**APPLICANT'S NAME/ADDRESS:** Lennar - Renaissance Homes (Jeff Panasiti)  
(916)773-4083  
2240 Douglas Blvd, Ste 250  
Roseville, Ca 95661

**APPROVAL:** This Planning Director's Special Permit (PDSP) approval is for **129 lots** in the Northpointe Park Villages 12. After approval of the PDSP, the following entitlements are required prior to construction of the residential development: 1) Zoning Administrator's Special Permit for a Model Home Complex; and 2) Building Permit.

**PROJECT INFORMATION:**

Zoning -	R-1-PUD	Range in House Size -	2,346 to 4,245 sf
Typical Lot Size -	65 feet x 105 feet	Range in Price -	\$235,000- 340,000
Number of Lots -	129 lots	Number of Models -	4
Gross Acres -	26.3 acres	Number of Elevations -	3
Net Acres -	21.7 acres	No. of Color Palettes -	3 per elevation
Net Density -	5.9 du/na		

**BACKGROUND:**

On December 19, 1996, the Planning Commission approved the Tentative Master Parcel Map and Tentative Subdivision Map for the Northpointe Park project (P96-058). On February 4, 1997, the City Council approved the Development Agreement, Plan Amendments to make amendments to land use, a Rezone to be consistent with the NNCP, and a PUD Designation, including the PUD Schematic Plan

and Guidelines. In approving the PUD Guidelines, the Council determined that a Planning Director's Special Permit, in lieu of a Planning Commission Special Permit, was required for single family / two family residential development within the PUD.

The applicant is requesting approval of a Planning Director's Special Permit for four single family house plans on 129 lots within Village 12 of the Northpointe Park PUD (see Vicinity Map). Village 12 is located at the northeast corner of North Bend Drive and Baines Avenue, east of the southern end of the community park.

**House Plans:** Please see Table 1 below regarding information for each house plan. The typical lot size is 65 feet wide by 105 feet deep, or 6,825 square feet.

**Table 1**

Plan #	# Stories	# Bedrooms (# / optional)	Garage Stalls	Square Footage (House/ Garage/ Porch)	Porch (sf)	Relation of Garage to House	% Lot Coverage
652	1	4/5	3S	(2,346 / 662 / 118)	118	Garage projects 10'	46% <sup>4</sup>
653	2	4	3S	(2,933 <sup>1</sup> / 713 / 153)	153	Garage projects 2'	40%
654	2	5	2T	(3,466 <sup>2</sup> / 691 / 58)	58	Garage recessed 14'	38%
655 <sup>3</sup>	2	5/6	3S	(3,605 <sup>3</sup> / 700 / 107)	107	Garage projects 14'	37%

Notes- S= split garage (2 car garage and a 1 car garage) T= tandem (2 car garage faces street, 3<sup>rd</sup> car internal)

1- The first floor square footage used to calculate lot coverage is 1,958 sf.

2- The first floor square footage used to calculate lot coverage is 1,785 sf.

3- The first floor square footage used to calculate lot coverage is 1,796 sf.

4- The lot coverage shown includes all the porch square footage. When a porch, greater than 40 square feet in size is included, the lot coverage may be calculated excluding the porch. Excluding the porch, the lot coverage is 44% which complies with the maximum lot coverage of 45% for a single story home.

Other features of the house plans include:

**Plan 652:** Only single story home; split 3 car garages (2 car and single car garages face the street); garages project 10 feet in front of porch; large porch spans the house between both garages; bedroom 4 and entry face the street; Options: 1) bedroom 4, which faces the street, can be converted to a den; 2) single car garage may be converted to a guest suite; 3) upper floor loft bedroom option; 4) upper floor loft bonus room option.

**Plan 653:** Smallest two story home; split 3 car garages (2 car and single car garages face the street); garage projects 2 feet in front of porch; large porch spans the house between both garages; living area and entry face the street; Options: 1) bedroom 5 in lieu of single car garage; 2) den in lieu of single car garage; 3) bonus room over family room; 4) game room with balcony over 2 car garage.

**Plan 654:** Mid size two story home; 3 car tandem garage (2 car door faces street with 3<sup>rd</sup> car internal); living area projects 14 feet in front of the garage; small entry porch; optional

garage door into the backyard; Options: 1) den in lieu of bedroom 5; 2) loft in lieu of bedroom 4; 3) super family room in lieu of 3<sup>rd</sup> car garage; 4) bedroom 6 in lieu of 3<sup>rd</sup> car garage.

**Plan 655:** Largest two story home; split 3 car garages (2 car garage faces street, single car garage side on to street); side on garage projects 19 feet in front of porch; living room and entry face the street; Options: 1) game room in lieu of single car garage; 2) guest suite in lieu of single car garage; 3) retreat in lieu of bedroom 2; 4) bonus room over living room; 5) bedroom 6 and sitting room over living room; excellent corner plan because living room and dining room face the street and the plan has a 45 degree entry feature.

Corner Lots: Twenty-one corner lots are included in the village (see Exhibit 1). The following plans are acceptable on a corner lot: Plan 652 with living space in lieu of the third car garage, Plan 653 with living area in lieu of the third car garage, Plan 654, and Plan 655. On each corner lot, the driveway shall be located away from the intersection of streets. The following plans are problematic on a corner lot and will be conditioned to be allowed on an interior lot only: Plan 652 with the third car garage, Plan 653 with the third car garage,

Plan 652: Planning staff is concerned about Plan 652 because: 1) no living area faces the street unless the third car garage is converted into living area and 2) the majority of the front elevation is devoted to the garages. Planning staff would suggest the following conditions be required for Plan 652: 1) A maximum of 50 percent of all the Plan 652 homes throughout Village 12 may be constructed with the three car garage option; and 2) Plan 652 shall be allowed on interior lots only unless the third car garage is converted to living area. The applicant has agreed to these conditions. If compliance with the 50 percent maximum 3 car garage condition on Plan 652 proves infeasible as the homes are built, the home builder can request a modification to the condition through a Planning Director's Special Permit Modification. Planning staff will work with the applicant on such a request and the Planning Director may approve, modify, or deny the requested condition change.

The homebuilder is intending to model each of the proposed house plans: Plans 652, 653, 654, and 655. Each plan will be modeled with the optional space in the single car garage.

**Height, Setbacks, and Lot Coverage:** The proposed heights of the homes are one and two stories which is in compliance with the maximum height of 35 feet. The minimum required setbacks are provided as shown below:

	<u>Required</u>	<u>Provided</u>
FRONT:	16 feet for the living area and 14 feet for the porch	Varies with each plan, minimum is met Varies with each plan, minimum is met
DRIVEWAY:	20 feet (per Public Works requirements)	20 feet
SIDE:	5 feet	5 feet
REAR:	15 feet	15 feet

According to the PUD Guidelines, the maximum lot coverage is 45 percent for single story homes with an allowance for porches and recessed garages and 40 percent for two story homes with the same allowance. As noted in Table 1 above, all of the proposed plans, except Plan 652, comply with the maximum lot coverage without the allowance. Plan 652 covers 46 percent of the typical lot (65 feet wide by 105 feet deep). Using the porch allowance (subtracting the 118 square foot porch) results in a lot coverage of 44 percent, which complies with the PUD lot coverage standard. Because the house is no larger in mass or taller in height than a single story home and the second story window overlooks the side yard only (the front facing dormer window is for light only), Plan 652 is considered to be a single story home, in spite of the use of the attic space as optional living area.

**Elevations, Materials, and Colors:** Three elevations are proposed for each house plan. The building materials and features proposed for each elevation are shown below:

<u>Elevation</u>	<u>Materials</u>	<u>Features</u>
A- Monterey	Stucco	Concrete S-tile roof, heavy wood trim and wood shutters on all plans; deck with wood railing on rear elevation of Plan 655; balconies on Plans 653 and 654
B- Craftsman	Stucco and stone	Limestone veneer and heavy wood trim on all plans; gabled and shed roofs, and decorative vent in the gable on each plan
C- French Country	Stucco and stone	Ledgestone veneer on all plans; wrought iron railing on balcony on Plan 655; stone turret on Plan 655; stone wing wall on each plan; metal railing and oval window on Plan 653 and 654;

Three different color options will be offered for each house plan. The colors will be submitted for approval prior to issuance of a building permit. The roof is proposed to be concrete flat or S-shaped tile by Monier. A minimum 5:12 roof pitch is shown on the plans; particularly on the French Country elevations, a steeper roof pitch is proposed.

Enhanced side and rear elevations are required whenever the home faces a public street, park, canal, or other public space. Twenty one corner lots are included in the village and no lots back onto major streets. One lot sides on the community park to the west. Enhanced elevations shall include, at a minimum, stucco over foam trim, finished with a smooth texture instead of the rough texture of the house, and a four foot return of materials on the side elevation.

Planning staff finds the house plans and elevations to be of a high quality and excellent design.

**Landscaping:** Typical lot landscaping plans are provided for both the interior lots and the corner lots (see Exhibits 3, 4 and 5). Approximately two street trees per lot will be provided on the frontage at an average spacing of 20 to 30 feet on center. Also, each corner lot will be planted with two street trees at 20 to 30 feet on center and three accent trees. The street trees are shown on the diagram in the Natomas Park Design Review Handbook and accent trees are listed in the Recommended Plant Material List in the Northpointe Park PUD Guidelines. Front yard landscaping materials shall include, in addition to the street trees: one 15-gallon accent tree, one 5-gallon specimen shrub, 20 1-gallon foundation and accent shrubs, ground cover with a minimum spacing of 12 inch on center with decorative bark, and turf. Side yard landscaping shall include, in addition to the street and accent trees: one 5-gallon specimen shrub, ground cover with minimum spacing of 12 inch on center with decorative bark, and turf. Plant materials shall be selected from the plant list in the Northpointe Park PUD Guidelines Exhibit 12 or in the Natomas Park Design Review Handbook Figure VII-1, page 43.

**Fences and Walls:** All lots within the subdivision front on or side on to North Bend Drive and/or internal subdivision streets. No masonry walls are needed within the village. The acoustical study prepared by Brown Buntin Associates (dated September 29, 1998) for Natomas Park indicates that no noise mitigation is required to comply with the City's noise standard. Wood fence with steel posts shall be constructed on Lot 20 adjacent to the park and wood fence with wood posts will be provided elsewhere in the village per the Natomas Park Design Review Handbook, pages 28 and 29, attached as Exhibit 10.

**Air Quality Mitigation Strategy:** The master developer of Natomas Park, which includes Northpointe Park PUD and this village, has submitted an Air Quality Mitigation Plan. The Plan was adopted by Planning and Public Works. The homebuilder of this village is responsible for the following mitigation measures: 1) participation in the North Natomas Transportation Management Association (TMA); 2) install energy efficient windows, low emission water heaters, gas or electric outlets in the backyard, and ISDN wiring and connections (or current technological equivalent) in all the homes; and 3) provide information to homebuyers about electric vehicles and lawn equipment and the TMA.

**COMMENTS:**

Public notice was mailed to adjacent property owners by the applicant on June 2, 1999. No comments were received from the public notice. The project plans were presented by the applicant to the Natomas Community Association on April 20, 1999. NCA verbally commented that the plans are acceptable as proposed.

On February 4, 1997, the City Council ratified a Negative Declaration for the original project (P96-058). Potentially significant environmental issues regarding Animal Life, Noise, Land Use, and Cultural Resources were discussed and mitigated in this document. The proposed project was analyzed in this previous environmental document. No new issues or new information is known that would trigger additional environmental analysis. Section 15162 of the California Environmental Quality Act Guidelines provides that an additional Negative Declaration (or Environmental Impact Report) need not be prepared unless subsequent changes are proposed in the project, substantial changes occur with respect to the project circumstances, or new information of substantial importance to the project becomes known or available. A Mitigation Monitoring Plan was prepared for the mitigation measures identified in the previous Negative Declaration. The applicant shall comply with the Mitigation Monitoring Plan, when applicable to the proposed project.

Public Works staff comments require that a minimum 20 foot driveway be provided on each Plan. Also, Public Works staff has reviewed and approved the Transportation Systems Management and Air Quality (TSM) Plan for Natomas Park, including Northpointe Park PUD. TSM measures are being provided with these plans, and are included as conditions of approval.

Staff finds that the proposed house plans comply with all applicable General Plan, Community Plan, and Zoning Ordinance requirements, and are consistent with the Northpointe Park PUD Guidelines and Schematic Plan.

**ACTION:**

The Planning Director approves the requested Planning Director's Special Permit based on the following findings and subject to the following conditions:

**Findings:**

1. The proposed residential development is consistent with the objectives of the General Plan and the 1994 North Natomas Community Plan in that:
  - o the project is consistent with the General Plan land use designations;
  - o the project is consistent with the 1994 North Natomas Community Plan land use designations;

- o the project is consistent with policies related to land use, including residential densities and open space proximity;
  - o the project begins to develop planned North Natomas neighborhoods each focused on an elementary school, with a variety of housing densities and types, and commercial, civic, transit, and park uses close by; and
  - o the project advances City transportation management and air quality goals.
2. The proposed residential development is consistent with the adopted PUD Guidelines and Schematic Plan for the Northpointe Park PUD in that the housing designs provided comply with requirements related to setbacks, height, and lot coverage and meet the purposes and criteria stated in the City Zoning Ordinance Sections 8A and 8B in that the PUD facilitates mixed residential uses designed to assure that new development is healthy and of long lasting benefit to the North Natomas community and the City; and
  3. The proposed residential development will not be detrimental to the public health, safety or welfare in that the single family residential development will be in harmony with the general purposes and intent of the Zoning Ordinance in that the approved elevations are well-designed; and that the proposed uses will not create a negative impact on any nearby sensitive uses.

**Conditions:**

1. The design of the proposed house plans shall substantially conform to the plans as shown on Exhibits 1 thru 9, specifically:
  - a. Elevation B - French Country shall have stucco and ledgestone veneer standard as shown on the attached exhibits and Elevation C- Craftsman shall have stucco and limestone veneer standard as shown on the attached exhibits;
  - b. A maximum of 50 percent of all the Plan 652 homes throughout Village 12 may be constructed with the three car garage option;
  - c. Plan 652 and Plan 653 shall be located on an interior lot only unless constructed with living space in the third car garage;
  - d. Roof pitch shall be no less than a 5 to 12 pitch;
  - e. The roof shall be finished with end and ridge caps; and
  - f. Three color palette options shall be offered for each elevation. The Planning Director shall approve the color options prior to the issuance of a building permit.

Any change in the design, materials or colors shall be submitted to the Planning Director for review and approval.

2. Prior to development of any model homes, the applicant shall obtain a Zoning Administrator's Model Home Special Permit.

3. The applicant shall obtain all necessary building permits prior to commencement of construction.
4. The applicant shall comply with the originally approved Mitigation Monitoring Plan (P96-058) on file at the Planning Division.
5. The Planning Director's Special Permit shall expire two years from date of issue, on June 22, 2001.
6. Air Quality Mitigation: The applicant shall comply with the Natomas Park TSMAQ Plan for residential development, including but not limited to the following:
  - a. Participate in the North Natomas Transportation Management Association (TMA);
  - b. Install low nitrogen oxide emitting, and/or high efficiency water heaters;
  - c. Install gas or electric outlets in the backyard;
  - d. Install energy efficient dual-pane windows, and/or energy efficient windows treated with reflective coatings; and
  - e. Provide new homeowners with information regarding alternative travel modes.
7. Street Trees - The parcel builder shall provide and install an average of two 15-gallon size trees per lot frontage, with the trees specified in the Street Tree Diagram and Matrix in the Natomas Park Design Review Handbook. These trees shall have an average spacing of 20' to 30' on center, as measured along the entire length of the street. For corner lots, the exposed side yard facing the street shall also be planted with two 15-gallon size trees as per the Street Tree Matrix and three accent trees selected from the Recommended Plant Material list in the Northpointe Park PUD Guidelines Exhibit 12. If spacing is interrupted by street lights or driveways, the trees shall be re-spaced to accommodate required clearances while maintaining the required quantity of trees on average. All planting shall conform to City standards for sight line requirements at intersections and driveways.
8. Landscaping - Front yard landscaping materials shall include, in addition to the street trees: one 15-gallon accent tree, one 5-gallon specimen shrub, 20 1-gallon foundation and accent shrubs, ground cover at a maximum spacing of 12 inch on center with decorative bark, and turf. Side yard landscaping shall include, in addition to the street and accent trees: one 5-gallon specimen shrub, ground cover with a maximum spacing of 12 inch on center with decorative bark, and turf. Plant materials shall be selected from the plant list in the Northpointe Park PUD Guidelines Exhibit 12 or in the Natomas Park Design Review Handbook Figure VII-1, page 43. All planting shall conform to City standards for sight line requirements at intersections and driveways. Exhibits 2 and 3 detail the proposed landscaping and irrigation.
9. Fencing and Walls - No masonry walls are required within Village 12. A wood fence with steel posts shall be required along the west side of Lot 20 adjacent to the community park per Exhibit 10. All other fencing shall be wood fence with wood posts per Exhibit 10. Side and rear yard fences visible from the park and other public areas which are composed of wood shall have continuous top and bottom rails. All fencing visible to the public shall have a semi-transparent stain in a neutral tone to be specified by the Natomas Park Design Review Committee. The location of fencing for interior and corner lots shall be as shown on Exhibits 3 and 4, specifically for corner lots fencing shall not commence until the back of the

house. Side yard fences up to six feet (6'-0") in height from house grade are allowed. Within the front setback area, no fence or wall shall be greater than 3'-6" in height. All fencing shall conform to City standards for sight line requirements at intersections and driveways.

10. Design Enhancements on Visible Elevations: For corner lots, design enhancements shall be provided on the exterior street side. Window enhancements include a stucco "pop-out" (foam trim with stucco overlay) sanded to a finished texture that is different from the texture of the house. Other enhancements include a four foot return of the veneer material used on the front, shutters, gable vents, etc. For Lot 20 which sides on to the future community park, window enhancements shall be provided on the entire side elevation.
11. Driveways - Driveways shall have a pattern of score lines to minimize the expanse of concrete. "Hollywood style" driveways are encouraged with a minimum 2 foot 6 inch planter strip between the two driveways.

APPROVED ON: June 22, 1999

PREPARED BY:

  
Carol Shearly, Associate Planner

APPROVED BY:

  
Scot Mende, Senior Planner

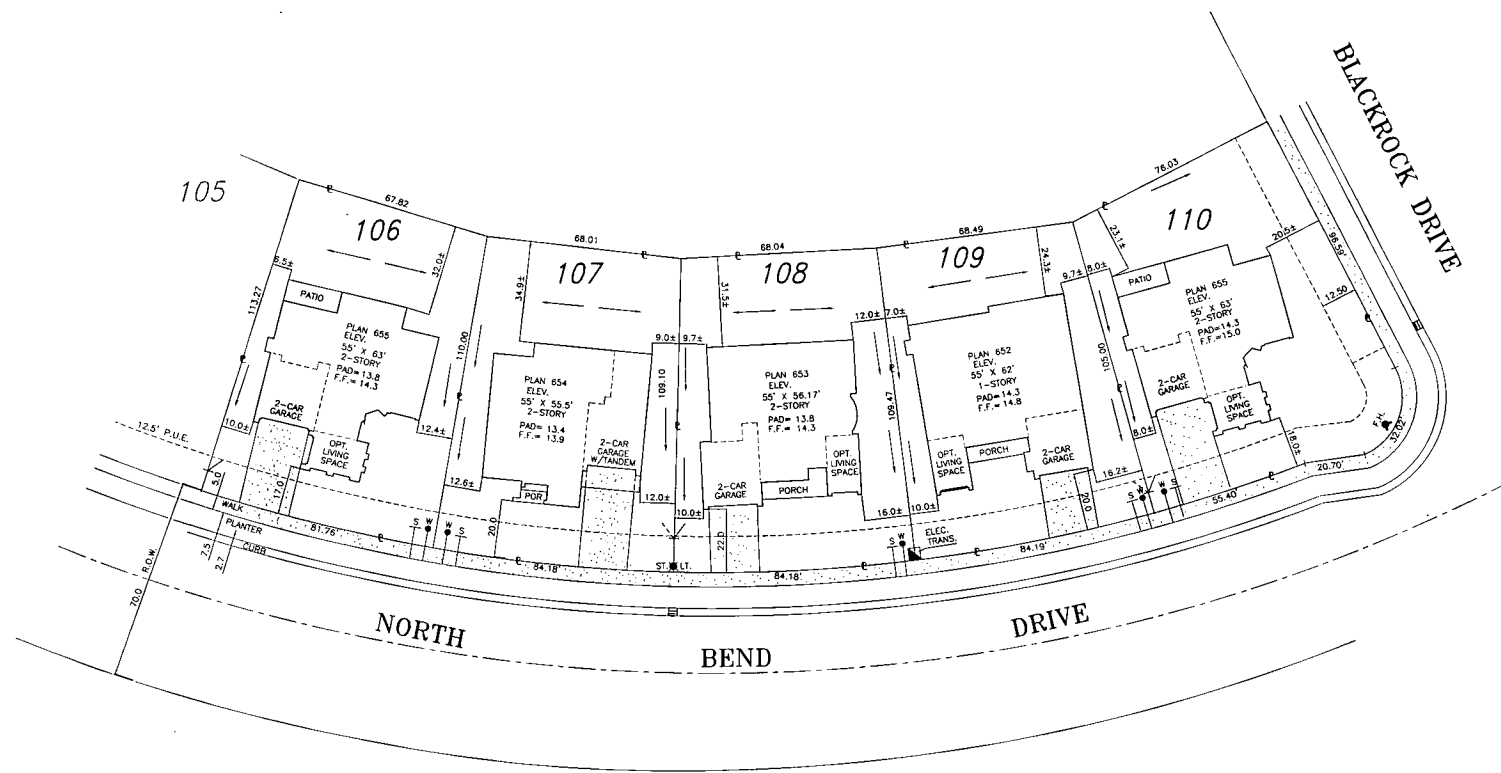
Attachments:

Vicinity Map  
Exhibit 1: Site Plan  
Exhibit 2: Setback Exhibit  
Exhibit 3: Planting Plan Sheet L1  
Exhibit 4: Planting Plan Sheet L2  
Exhibit 5: Irrigation Plan / Schedules - Sheet L3  
Exhibit 6: Plan 652 - Floor Plan, Elevations and Options  
Exhibit 7: Plan 653 - Floor Plan, Elevations, and Options  
Exhibit 8: Plan 654 - Floor Plan, Elevations, and Options  
Exhibit 9: Plan 655 - Floor Plan, Elevations, and Options  
Exhibit 10: Wall and Fence Detail  
Exhibit 11: Natomas Park Design Review Committee Approval Letter

File: Original  
cc: Applicant  
Development Services - Building Division (2)  
PUD Binder

C:\data\wpf\p-files\P99-071





LOT COVERAGE CALCULATIONS

PLAN	PLAN SQ. FT.	LOT	LOT SQ. FT.	LOT COVERAGE	TYPICAL LOT	TYPICAL LOT SQ. FT.	TYPICAL LOT COVERAGE
652 (1-STORY)	3,027	109	8243.55	36.7 %	65'x105'	6,825	44.4 %
653 (2-STORY)	2,687	108	8382.64	32.1 %	65'x105'	6,825	39.4 %
654 (2-STORY)	2,473	107	8400.79	29.4 %	65'x105'	6,825	36.2 %
655 (2-STORY)	2,486	106	8405.49	29.6 %	65'x105'	6,825	36.4 %
655 (2-STORY)	2,486	110	9695.05	25.6 %	65'x105'	6,825	36.4 %

LOT COVERAGE FOR A 1-STORY HOME NOT TO EXCEED 45 %  
 LOT COVERAGE FOR A 2-STORY HOME NOT TO EXCEED 40 %

General Notes

NOTE: CURVED LINES ARE CHORD MEASUREMENTS.

NORTHPOINTE PARK  
 VILLAGE 12

SETBACK EXHIBIT



2240 DOUGLAS BLVD., SUITE 250  
 ROSEVILLE, CALIFORNIA 95661

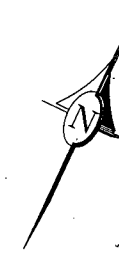
No.	Revision/Issue	Date

Project Name and Address  
 NORTHPOINTE PARK  
 UNIT NO. 12

CITY OF SACRAMENTO, SACTO. CO., CA.

Sheet NORTHPOINTE VILLAGE 12	1
Date APRIL 28, 1999	of 1
Scale 1"=20'-0"	

Exhibit 2 P99-071

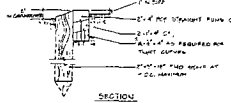




PLANT LIST		
SYMBOL	BOTANICAL NAME	COMMON NAME
TI	APPROVED STREET TREE - SEE COMMUNITY LIST	N/A
LA	LAGERSTROEMIA INDICA 'CHEROKEE'	CRANE WYTHLE
PR	PRUNUS CERASIFERA 'NARAIER VESUVIUS'	PURPLE LEAF FLOWERING PLUM
AG	AGAPANTHUS AFRICANUS 'PETER PAN'	DWARF LILY OF THE VALLE
DI	DIERIS VEGATA	FORTNIGHT LILY
ET	ESCALLONIA TERRY	N.C.N.
LD	LAGERSTROEMIA 'PETITE EMBERS'	BUSH CRANE WYTHLE
LI	LOUSTELUM TEXANUM	TEXAS PRYLET
NA	NANDINA DOMESTICA	HEAVENLY BAMBOO
PH	PHOTINIA FRASESI	RED TIP PHOTINIA
PO	PODOCARPUS MACROPHYLLUS 'MAK'	YEW PINE
PV	PITTOSPORUM TOBIRA 'VARIEGATA'	VARIEGATED MOCK ORANGE
PW	PITTOSPORUM TOBIRA 'WHEELER'	DWARF MOCK ORANGE
RB	RHAMNOLIPS INDICA 'BALLERINA'	DWARF INDIA HAWTHORN
RH	RHAMNOLIPS INDICA 'CLARA'	INDIA HAWTHORN
SA	SALVIA LEUCANTHA	MEXICAN SAGE
TR	TRACHELOSPERMUM JASMINOIDES	STAR JASMINE

### GENERAL INSTALLATION NOTES:

1. Installer shall secure and pay for a soils test as required. Soils report shall be prepared by a qualified soils specialist and submitted to homebuilder for approval. Samples shall be collected following rough grading operations. At a minimum, the following shall be included in the report:
  - a) Soil infiltration
  - b) Soil texture
  - c) Cation exchange capacity
  - d) Soil fertility including tests for nitrogen, potassium, phosphorus, pH, organic matter, and specific conductance (E.C.).
 Prior to planting, amendments shall be added to correct for problems as noted by the soils report.
2. All areas that cannot be surface drained shall be drained using 3" diameter ADS drain lines, NDS fittings, etc. All roof downspouts (front and rear yards) shall be connected to underground system.
3. All lawn areas shall be a turf-type Tall Fescue blend sod (95%/5% blend).
4. All shrub and groundcover areas shown on plan shall be topdressed with a 2" minimum layer of 1/4" fir bark (1/4"-1/2" diameter) as available from Valley Rock / Loomis, CA (916) 652-7209.
5. Apply pre-emergent herbicide ('Ronstar' or equal) to all shrub and groundcover areas per manufacturer's suggested rate.
6. See details for additional information.



NOTE:  
 \* LANTERNS SHALL BE INSTALLED AND OPERATED AS REQUIRED  
 \* LANTERNS SHALL BE INSTALLED AS REQUIRED  
 \* LANTERNS SHALL BE INSTALLED AS REQUIRED  
 \* LANTERNS SHALL BE INSTALLED AS REQUIRED

REDWOOD\_HEADER

## TYPICAL PRODUCTION LANDSCAPE NORTHPOINTE PARK - VILLAGE 12

SACRAMENTO, CA

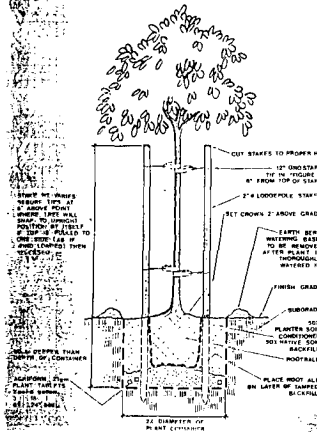
RENAISSANCE HOMES

SCALE: 1/8" = 1'-0"

## PLANTING PLAN SHEET L2



### TREE PLANTING



### SHRUB PLANTING

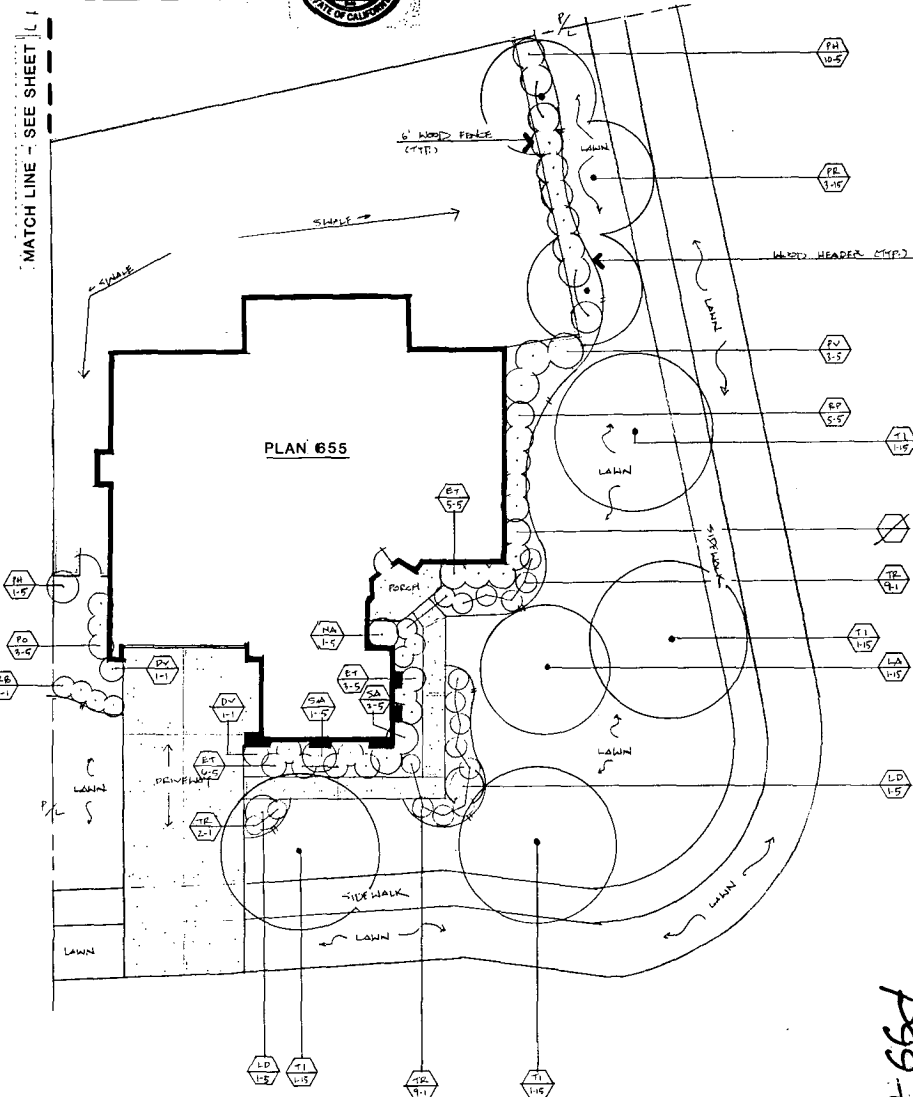
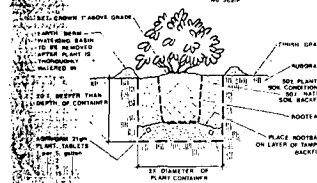


Exhibit 4  
 P99-071

IRRIGATION LEGEND					
SYM	MANUE	MODEL#	DESCRIPTION	GPM	PREC. RATE (IN HR)
1	RANBRD	1805-15Q	POP-UP SPRAY SPRINKLER WITH PCS SCREEN AS REQUIRED	0.53	2.34
2	RANBRD	1805-15T		0.7	2.34
3	RANBRD	1805-15H		1.05	2.34
4	RANBRD	1805-15F		2.15	2.34
5	HARDE	#HW1645	7" DIAMETER POLYETHYLENE MAIN DRIP TUBING WITH (1) 1 GPH SPOT EMITTER PER SHRUB AND (3) 1 GPH EMITTERS PER 15 GAL AND LARGER		
6	HARDE	#713DPR	ANTI-SIPHON CONTROL VALVE (1" SIZE)		
7	HARDE	RD000-4H	INDOOR MOUNT AUTOMATIC CONTROLLER		
8	NA	SCH. 40	SCHEDULE 40 PVC MAIN PRESSURE LINE		
9	NA	CLASS 200	CLASS 200 PVC LATERAL NON-PRESSURE IRRIGATION LINE		
10	RANBRD	CF-21	COMPRESSION FLUSH CAP INSTALLED BELOW GRADE IN PLASTIC VALVE BOX (SEE DETAIL)		
11	NA	NA	POINT OF CONNECTION AT WATER SERVICE TEE PROVIDED BY PLUMBER CONTRACTOR		

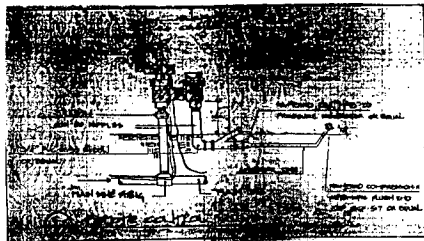
**WATER USE CALCULATIONS (per 654 sheet)**

**Maximum Applied Water Allowance (estimated):**

**MAWA:**  
 Planting area: 31.9 x 8 x 492ft x .62 = 12,665 gallons per year  
 Turf area: 31.9 x 8 x 1,737ft x .62 = 44,714 gallons per year  
 Total MAWA = 57,379 gallons per year

**Estimated Applied Water Use:**

**FAWA:**  
 Planting area: 31.9 x 8 x 492ft x .62 = 12,665 gallons per year  
 Turf area: 31.9 x 1.4 x 1,737ft x .62 = 48,806 gallons per year  
 Total FAWA = 61,471 gallons per year



**IRRIGATION SCHEDULE**

PROJECT NAME: NORTHPOINTE PARK - VILLAGE 12

IRRIGATION SCHEDULE:

ESTABLISHMENT PERIOD - (30 DAYS FOLLOWING PLANTING)

STATION #	TYPE	HYDROZONE	QEMPHZ	CYCLES/ DAY	CYCLE LENGTH(MIN)	DAYS/ WEEK
1	SPRAY	LAWN (HIGH)	18	2	10	3
2	SPRAY	LAWN (HIGH)	12	2	10	3
3	SPRAY	LAWN (HIGH)	19	2	10	3
4	DRIP	SHRUB (MED)	38	2	30	3

**IRRIGATION SCHEDULE**

PROJECT NAME: NORTHPOINTE PARK / VILLAGE 12

IRRIGATION SCHEDULE: SPRING (MARCH, APRIL, MAY)

(ESTABLISHED LANDSCAPE)

STATION #	TYPE	HYDROZONE	QEMPHZ	CYCLES/ DAY	CYCLE LENGTH(MIN)	DAYS/ WEEK
1	SPRAY	LAWN (HIGH)	18	2	10	1
2	SPRAY	LAWN (HIGH)	12	2	10	1
3	SPRAY	LAWN (HIGH)	19	2	10	1
4	DRIP	SHRUB (MED)	38	2	30	1

**IRRIGATION SCHEDULE**

PROJECT NAME: NORTHPOINTE PARK VILLAGE 12

IRRIGATION SCHEDULE: SUMMER (JUNE, JULY, AUGUST)

(ESTABLISHED LANDSCAPE)

CONTROL #	STATION #	TYPE	HYDROZONE	QEMPHZ	CYCLES/ DAY	CYCLE LENGTH(MIN)	DAYS/ WEEK
A	1	SPRAY	LAWN (HIGH)	18	2	10	2
A	2	SPRAY	LAWN (HIGH)	12	2	10	2
A	3	SPRAY	LAWN (HIGH)	19	2	10	2
A	4	DRIP	SHRUB (MED)	38	2	30	2

**IRRIGATION SCHEDULE**

PROJECT NAME: NORTHPOINTE PARK - VILLAGE 12

IRRIGATION SCHEDULE: AUTUMN (SEPT., OCT., NOV.)

(ESTABLISHED LANDSCAPE)

CONTROL #	STATION #	TYPE	HYDROZONE	QEMPHZ	CYCLES/ DAY	CYCLE LENGTH(MIN)	DAYS/ WEEK
A	1	SPRAY	LAWN (HIGH)	18	2	10	1
A	2	SPRAY	LAWN (HIGH)	12	2	10	1
A	3	SPRAY	LAWN (HIGH)	19	2	10	1
A	4	DRIP	SHRUB (MED)	38	2	30	1

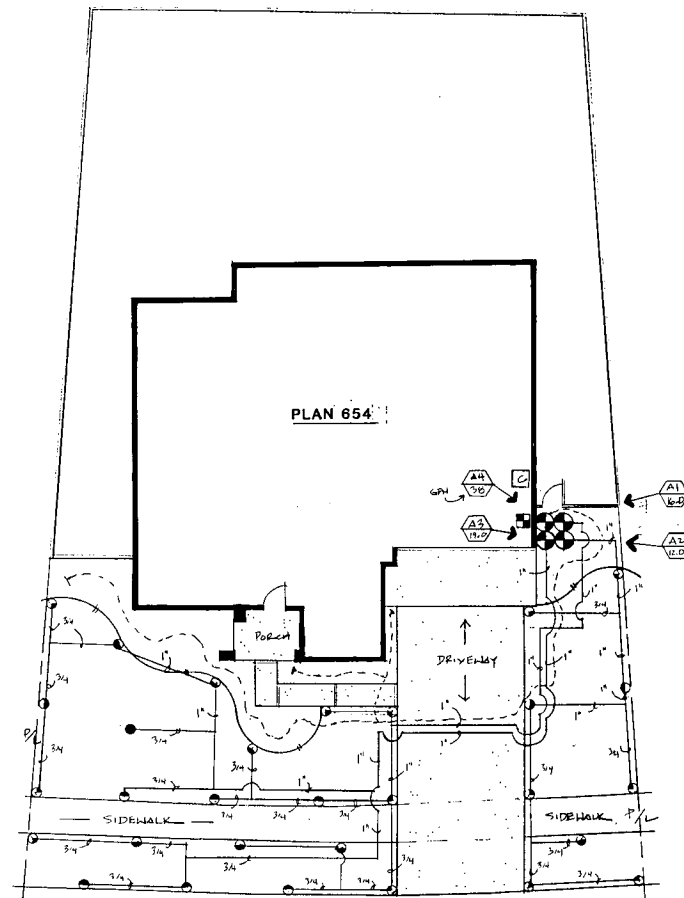
**IRRIGATION SCHEDULE**

PROJECT NAME: NORTHPOINTE PARK - VILLAGE #12

IRRIGATION SCHEDULE: WINTER (DEC., JAN., FEB.)

(ESTABLISHED LANDSCAPE)

CONTROL #	STATION #	TYPE	HYDROZONE	QEMPHZ	CYCLES/ DAY	CYCLE LENGTH(MIN)	DAYS/ WEEK
A	1	SPRAY	LAWN (HIGH)	18	0	0	0
A	2	SPRAY	LAWN (HIGH)	12	0	0	0
A	3	SPRAY	LAWN (HIGH)	19	0	0	0
A	4	DRIP	SHRUB (MED)	38	0	0	0



**TYPICAL PRODUCTION LANDSCAPE  
 NORTHPOINTE PARK - VILLAGE 12**

SACRAMENTO, CA

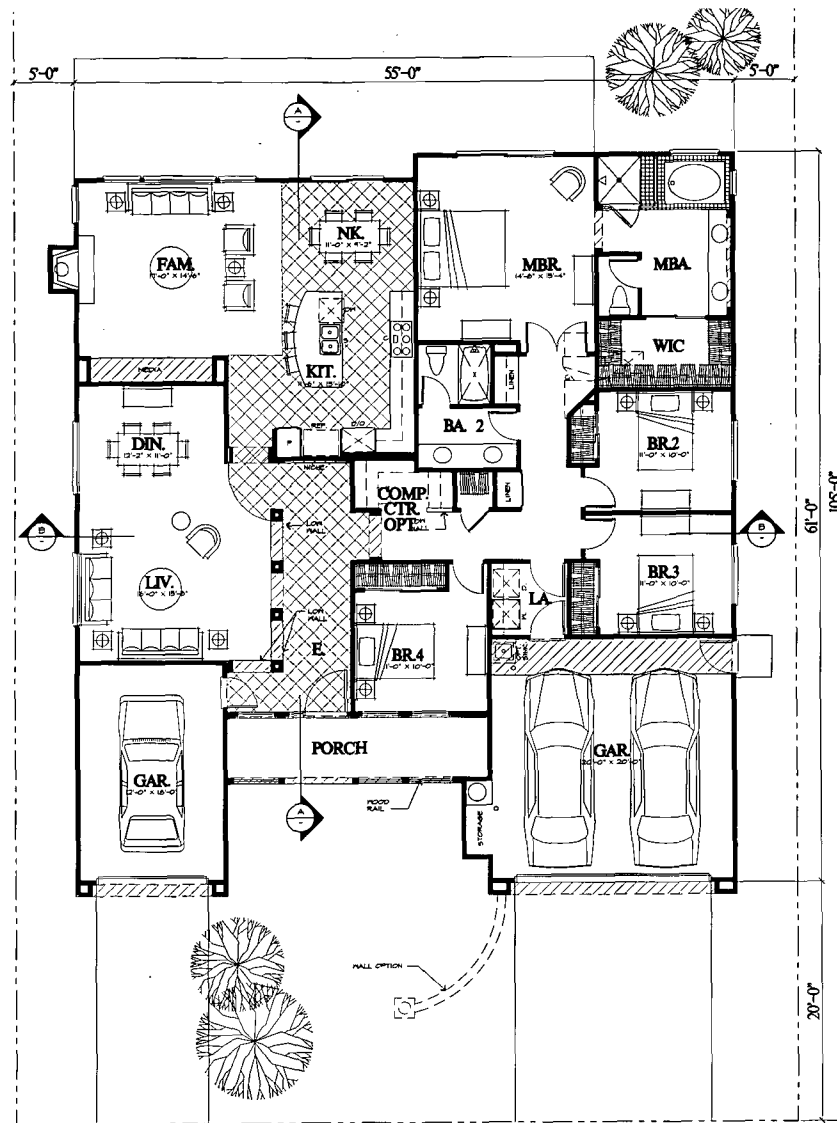
RENAISSANCE HOMES

SCALE: 1/8" = 1'-0"

**IRRIGATION PLAN / SCHEDULES  
 SHEET L3**



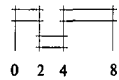
Exhibits  
 P99-071



PLAN 652  
 4 BR. 2 BA  
 2,346 SQ. FT.

LOWER LEVEL A

NATOMAS PARK



0 2 4 8

5/11/99



99009A



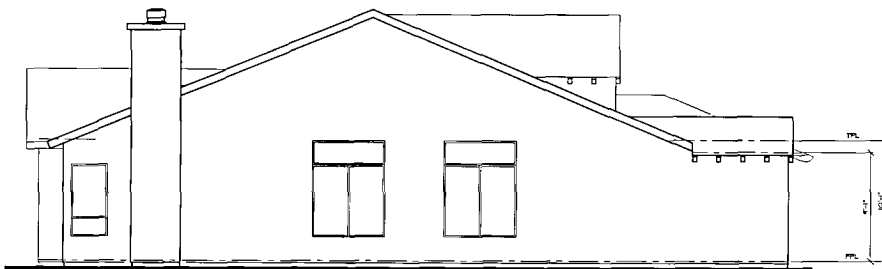
Exhibit 6a  
 P99-071



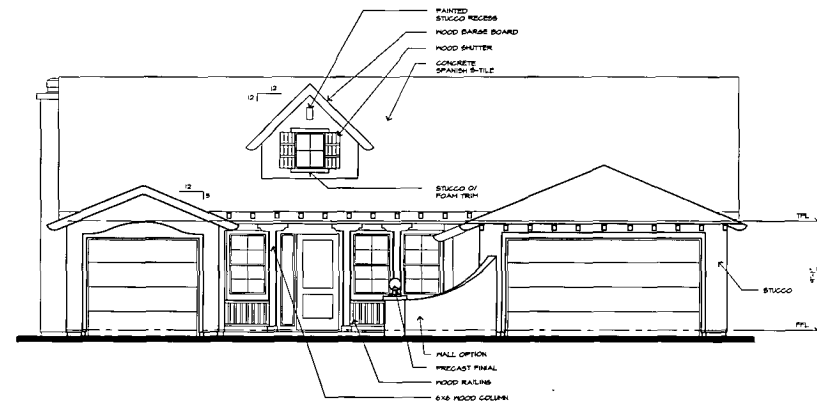
RIGHT ELEVATION A



REAR ELEVATION A

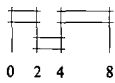


LEFT ELEVATION A



PLAN 652 - MONTEREY FRONT ELEVATION A

PLAN 652  
NATOMAS PARK



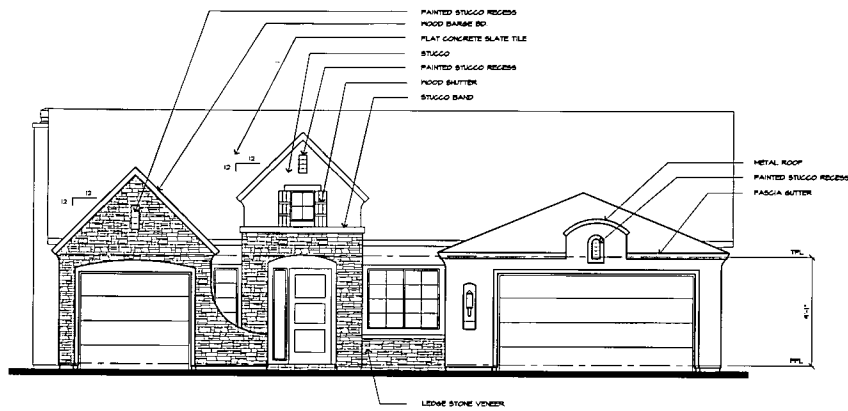
5/11/99



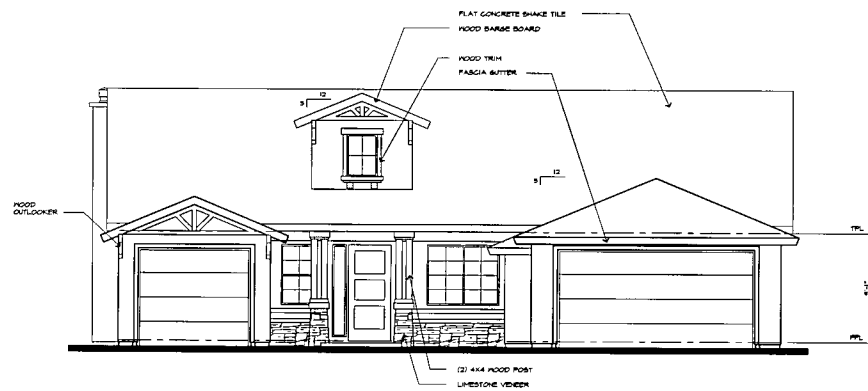
99009A



Exhibit 66  
P99-071  
5 OF  
28



PLAN 652 - FRENCH COUNTRY FRONT ELEVATION C



PLAN 652 - CRAFTSMAN FRONT ELEVATION B

PLAN 652  
NATOMAS PARK

0 2 4 8

5/11/99



99009A



Exhibit 6c  
P99-071

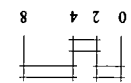
Exhibit 6d  
P99-071



99009A



5/11/99

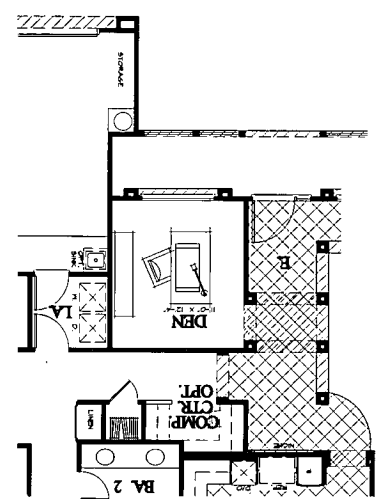


# NATOMAS PARK

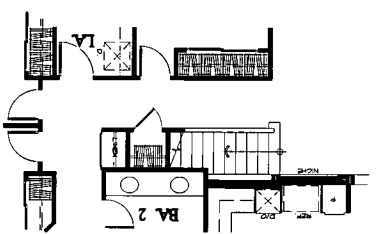
## OPTIONS

### PLAN 652

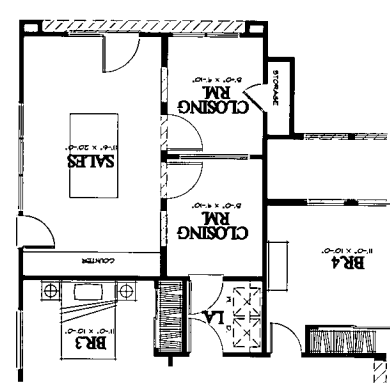
PLAN 652 - OPTION 1  
NO ADDITIONAL AREA  
NO ADDITIONAL AREA



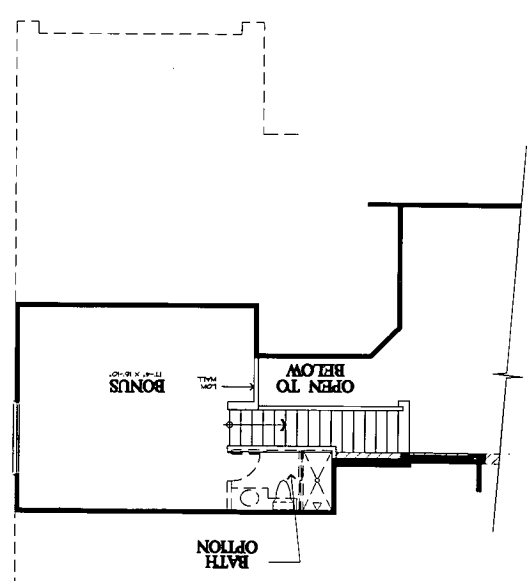
PLAN 652 - OPTION 3 & 4  
UPPER FLOOR REVISION OPTION  
NO ADDITIONAL AREA



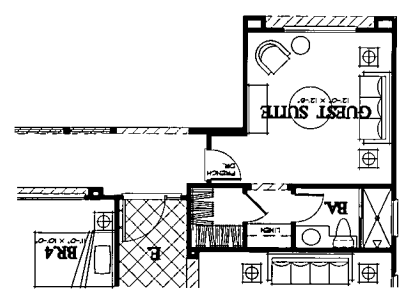
PLAN 652 - SALES OFFICE



PLAN 652 - OPTION 4  
UPPER FLOOR BOLD ROOM REVISION  
NO ADDITIONAL AREA



PLAN 652 - OPTION 2  
GUEST SUITE OPTION IN LIEU OF GARAGE  
NO ADDITIONAL AREA



PLAN 652 - OPTION 3  
UPPER FLOOR REVISION OPTION  
NO ADDITIONAL AREA

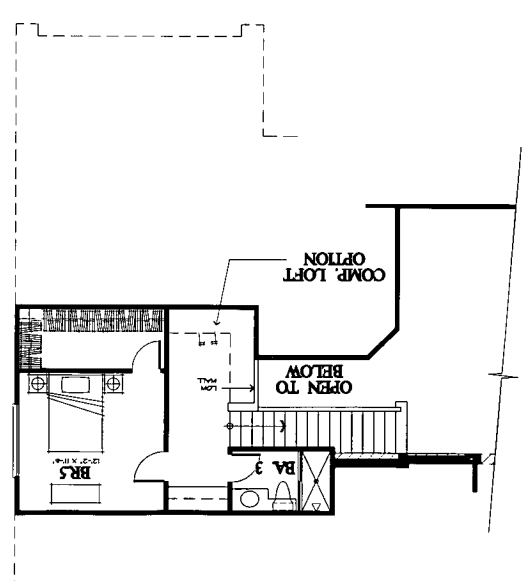
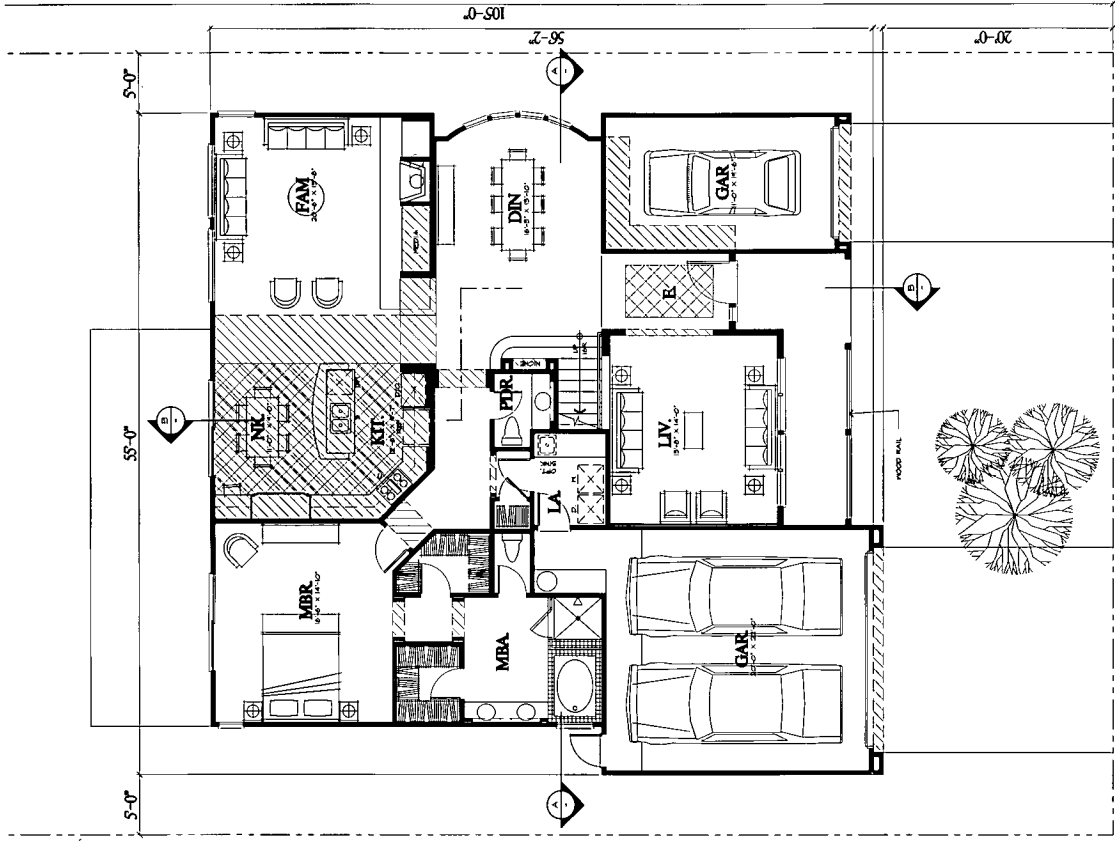


Exhibit 7a  
P99-071

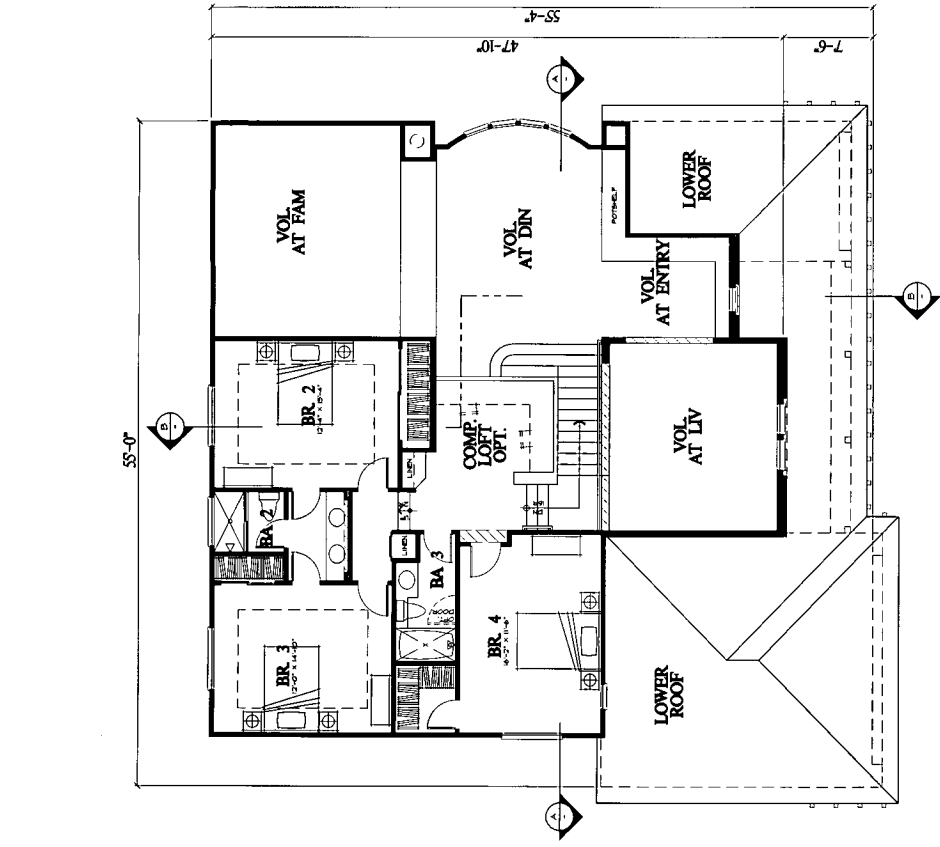
7 OF 28



LOWER LEVEL A  
COURT YARD AREA (NOT TO SCALE)



99009A



PLAN 653  
4 BR. 3.5 BA  
2,933 SQ. FT.

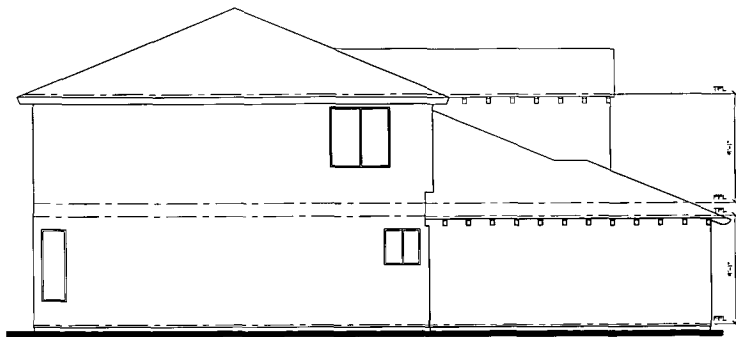
UPPER LEVEL A  
COURT YARD AREA (NOT TO SCALE)

NATOMAS PARK

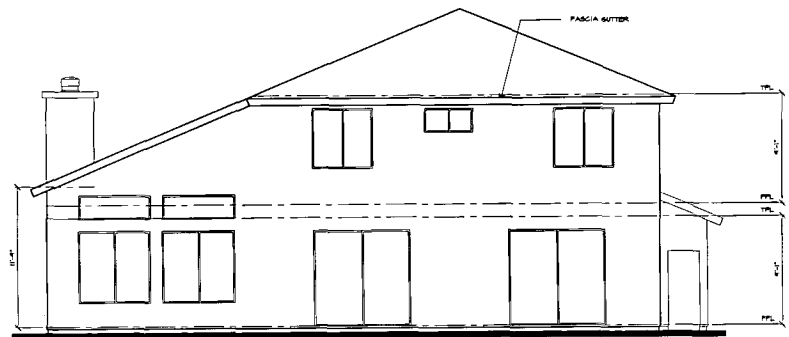
0 2 4 8

5/11/99

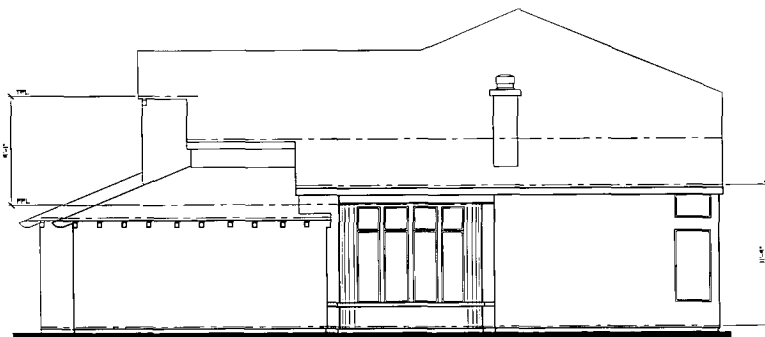




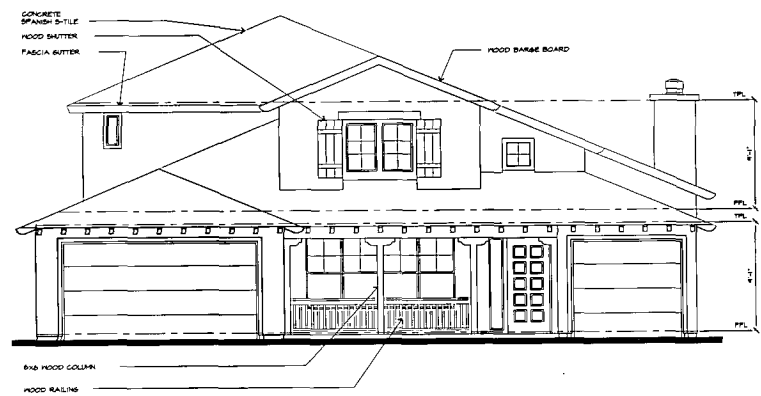
LEFT ELEVATION A



REAR ELEVATION A

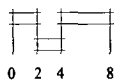


RIGHT ELEVATION A



PLAN 653 - MONTEREY FRONT ELEVATION

PLAN 653  
NATOMAS PARK



0 2 4 8

5/11/99



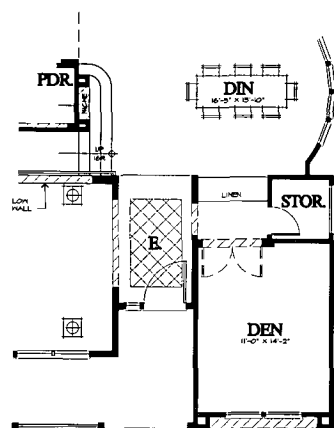
99009A



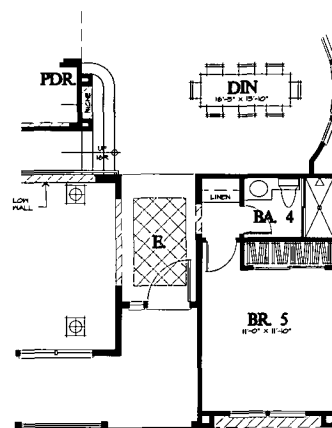
Exhibit 7b  
P99-071

B OF  
28





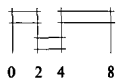
PLAN 653 - OPTION 2  
DEN OPTION  
299 SQ. FT.



PLAN 653 - OPTION 1  
BEDROOM 5 OPTION  
299 SQ. FT.

PLAN 653  
OPTIONS

NATOMAS PARK



0 2 4 8

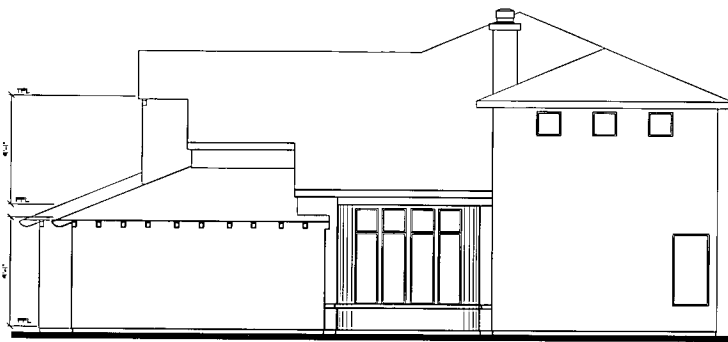
5/11/99



99009A



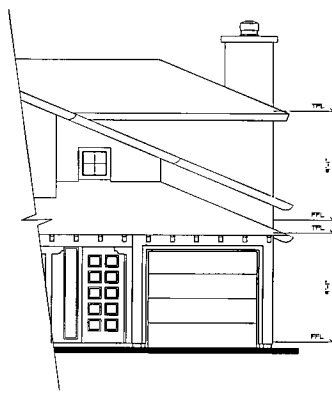
EXHIBIT 7d  
P99-071



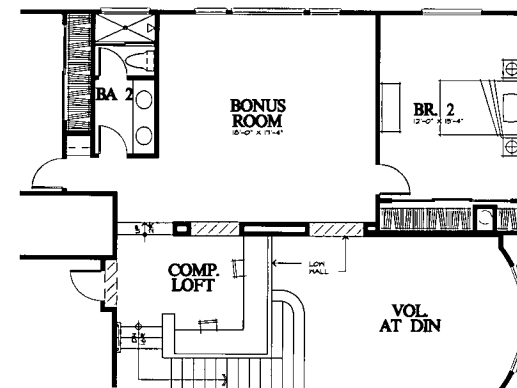
RIGHT ELEVATION A  
OPTION 3



REAR ELEVATION A  
OPTION 3

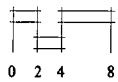


PLAN 653 - MONTEREY FRONT ELEVATION A  
OPTION 3



PLAN 653 - OPTION 3  
BONUS AND BEDROOM 3 OPTION  
571 SQ. FT.

PLAN 653 - OPTION 3  
NATOMAS PARK



5/11/99



99009A



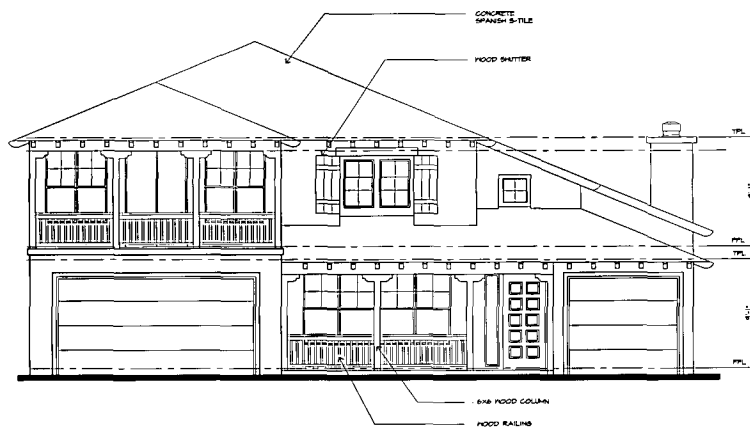
Exhibit 7e  
P99-071



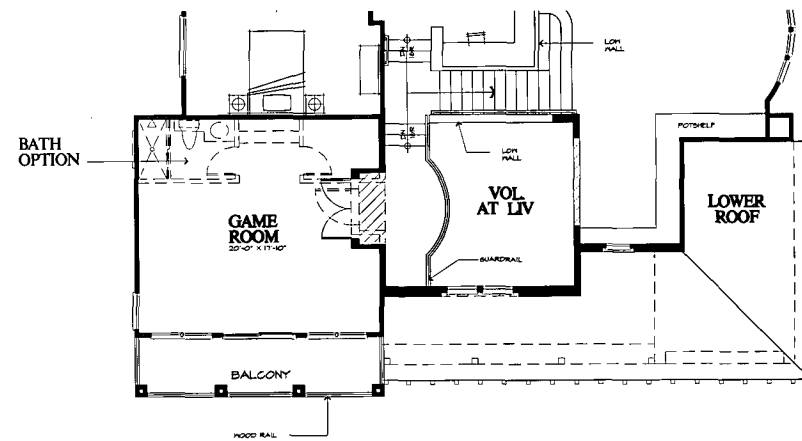
PLAN 653 - CRAFTSMAN FRONT ELEVATION B  
OPTION 4



PLAN 653 - FRENCH COUNTRY FRONT ELEVATION C  
OPTION 4

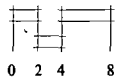


PLAN 653 - MONTEREY FRONT ELEVATION A  
OPTION 4



PLAN 653 - OPTION 4  
GAME ROOM OPTION  
449 SQ. FT.

PLAN 653 - OPTION 4  
NATOMAS PARK



0 2 4 8

5/11/99



99009A



EXHIBIT 7F  
P99-071

Exhibit 8a  
P99-071

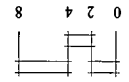
15 OF  
28



99009A



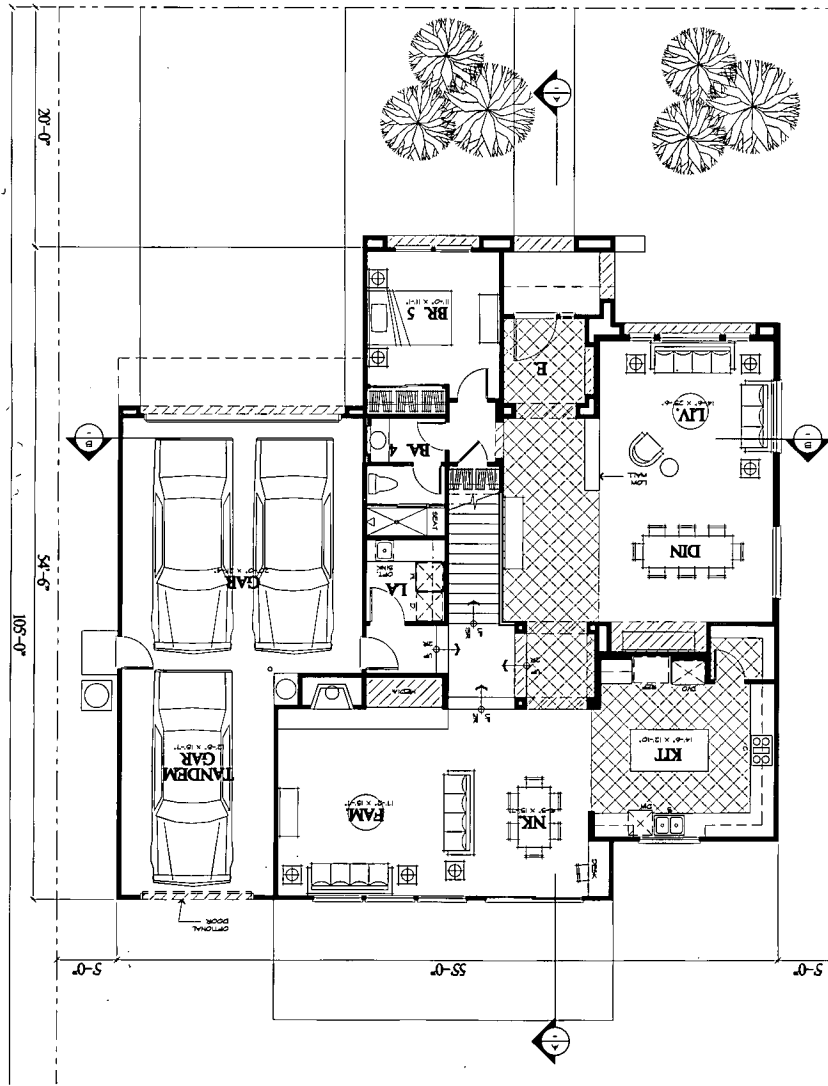
5/11/99



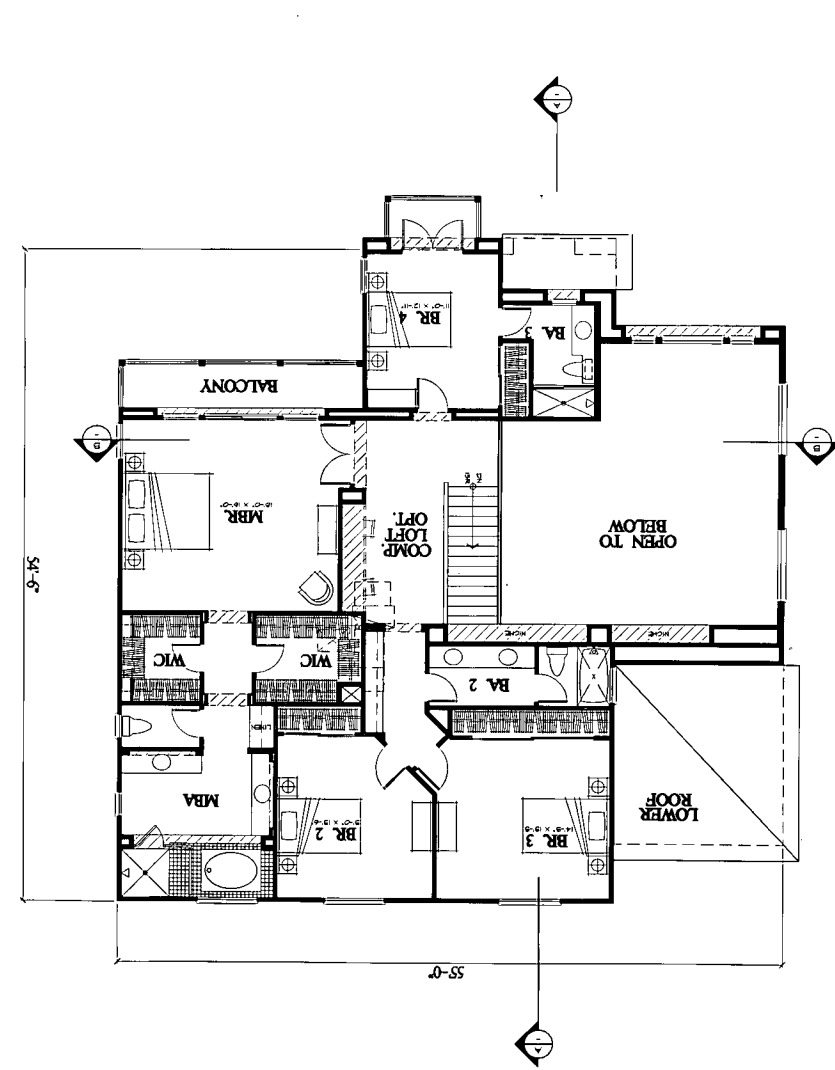
# NATOMAS PARK

PLAN 654  
5 BR 4 BA  
3,466 SQ. FT.

LOWER LEVEL A  
LOWER FLOOR AREA: 1,789 SQ. FT.

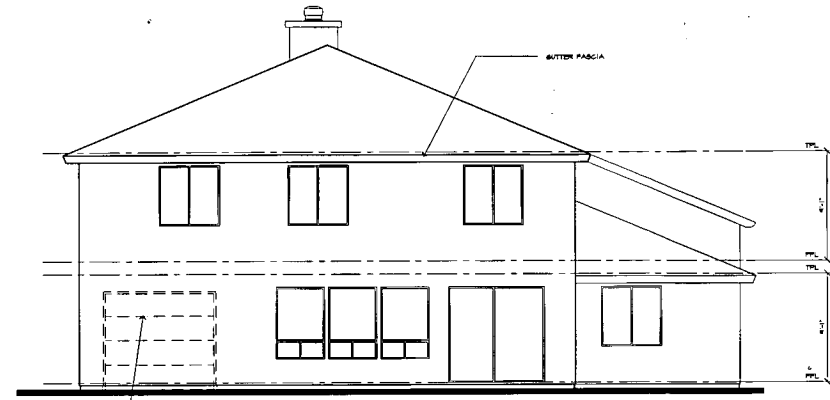


UPPER LEVEL A  
UPPER FLOOR AREA: 1,677 SQ. FT.





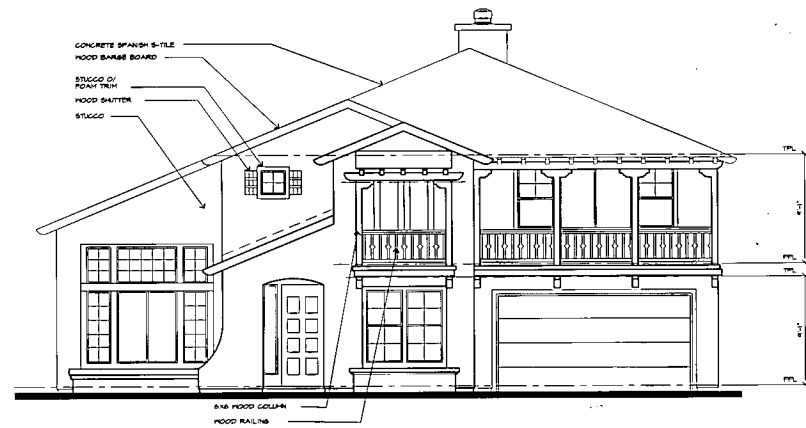
RIGHT ELEVATION A



REAR ELEVATION A

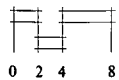


LEFT ELEVATION A



PLAN 654 - MONTEREY FRONT ELEVATION A

PLAN 654  
NATOMAS PARK



5/11/99

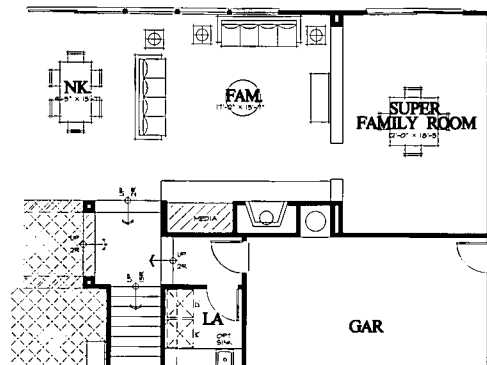


99009A

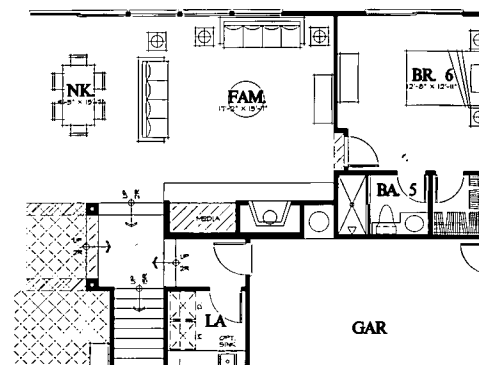


Exhibit 8b  
P99-071

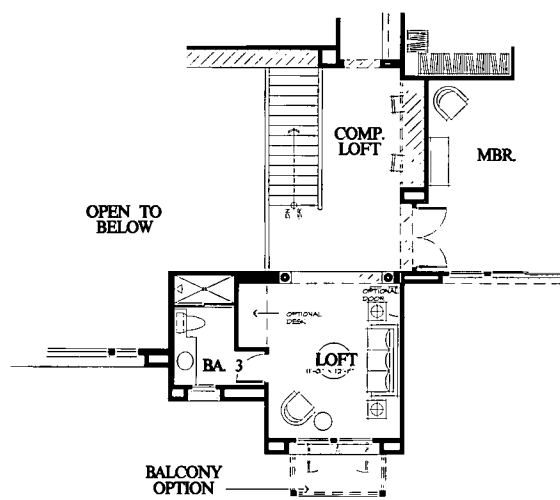




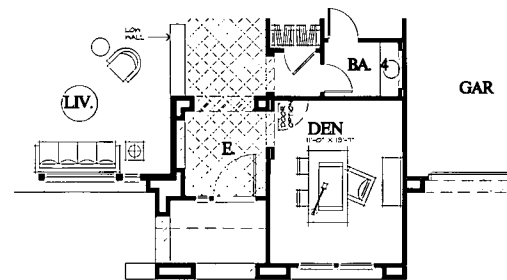
PLAN 654 - OPTION 3  
SUPER FAMILY ROOM OPTION  
248 SQ. FT.



PLAN 654 - OPTION 4  
BEDROOM OPTION  
248 SQ. FT.



PLAN 654 - OPTION 2  
LOFT OPTION  
NO ADDITIONAL AREA



PLAN 654 - OPTION 1  
DEN OPTION  
NO ADDITIONAL AREA

PLAN 654  
OPTIONS  
NATOMAS PARK



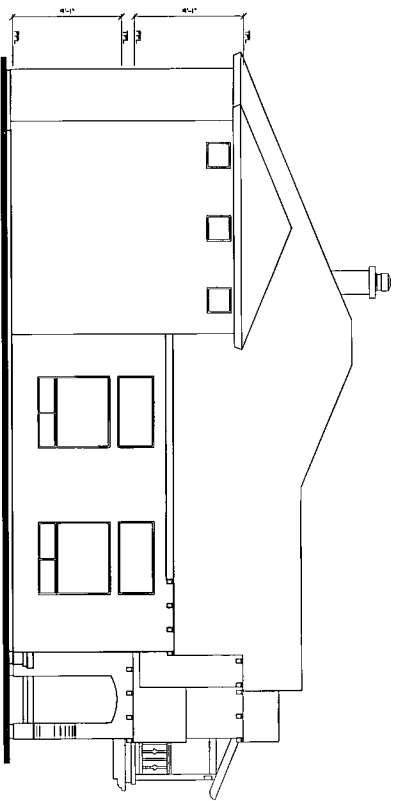
5/11/99



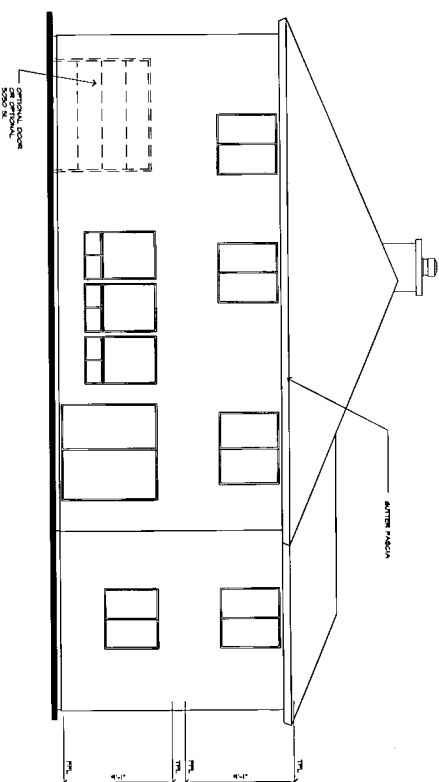
99009A



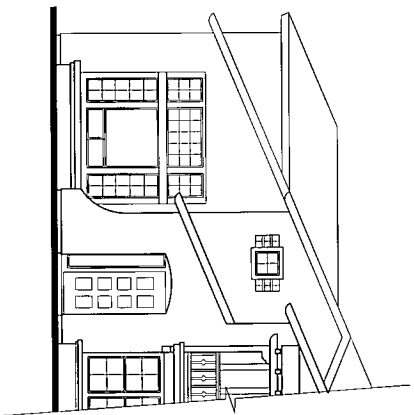
Exhibit Bd  
P99-071



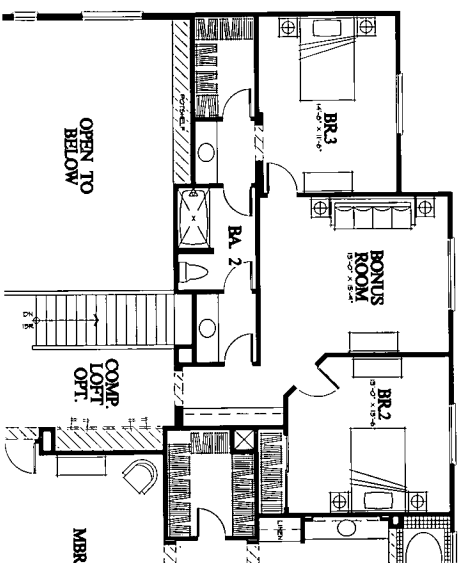
LEFT ELEVATION A  
OPTION 5



REAR ELEVATION A  
OPTION 5

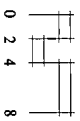


MONTEREY FRONT ELEVATION A  
OPTION 5



PLAN 654 - OPTION 5  
SHEET NO. 21 OF 22

PLAN 654 - OPTION 5  
NATOMAS PARK



5/11/99



99009A



Exhibit 8c  
Pg 9 of 11

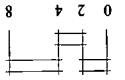
Exhibit 9a  
P99-071



99009A



5/1/99

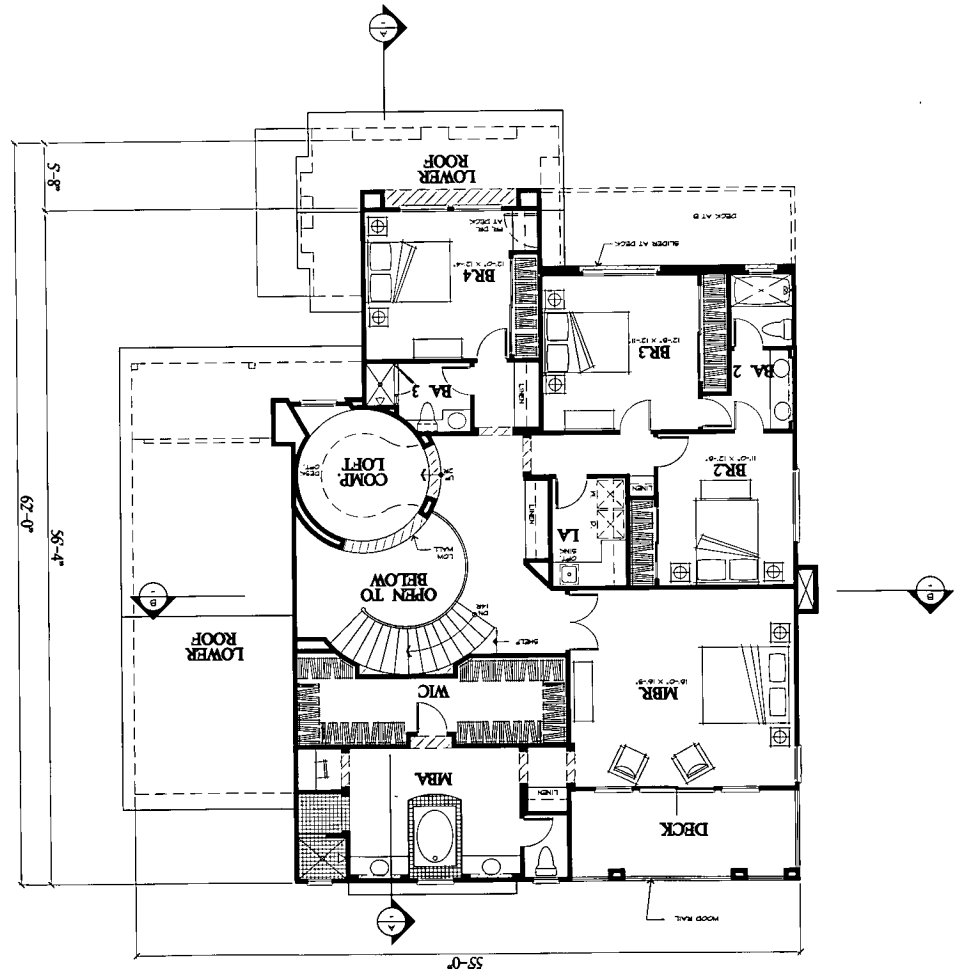
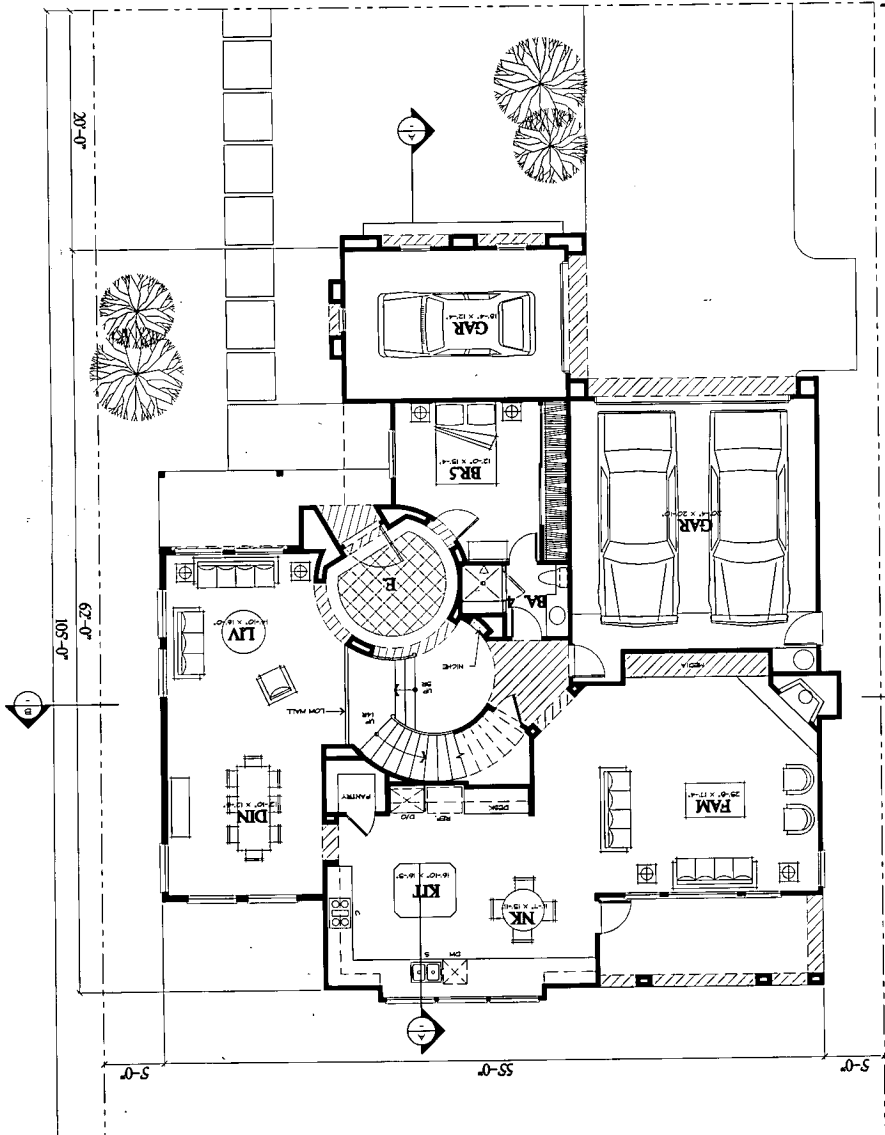


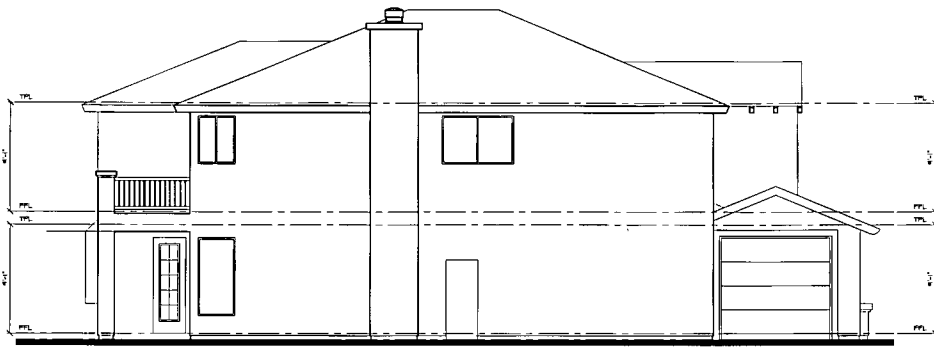
# NATOMAS PARK

PLAN 655  
5 BR, 4 BA  
3,605 SQ. FT.

LOWER FLOOR AREA 1,978 SQ. FT.

UPPER FLOOR AREA 1,627 SQ. FT.

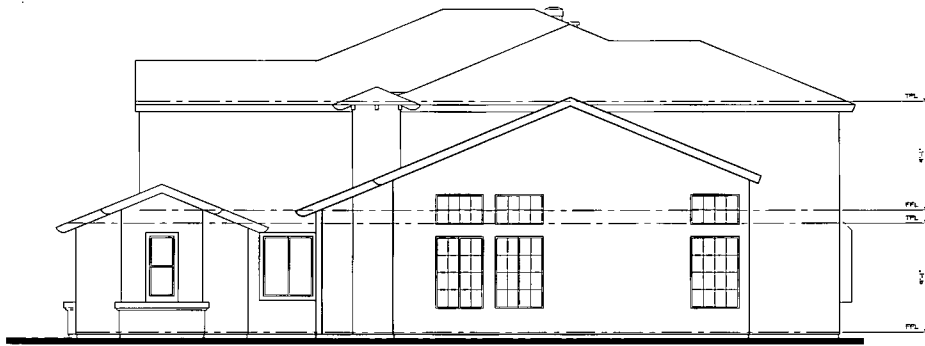




LEFT ELEVATION A



REAR ELEVATION A

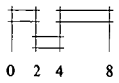


RIGHT ELEVATION A



PLAN 655 - MONTEREY FRONT ELEVATION A

PLAN 655  
NATOMAS PARK



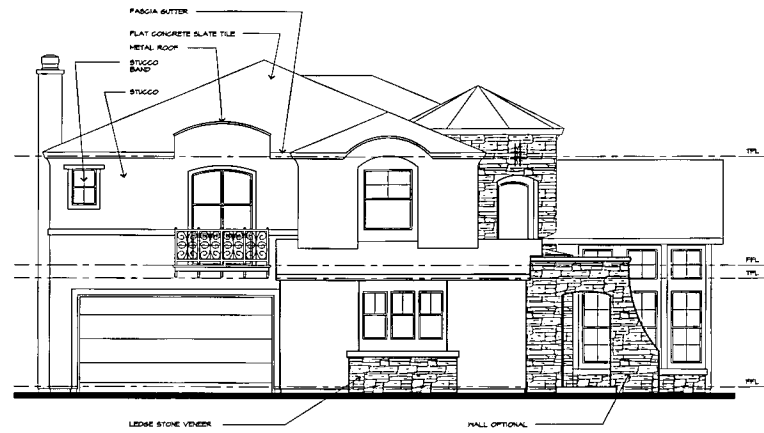
5/11/99



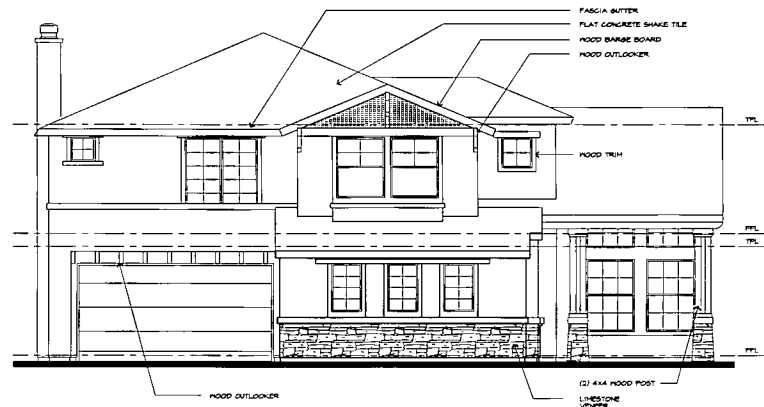
99009A



Exhibit 96  
P99-071

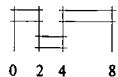


PLAN 655 - FRENCH COUNTRY FRONT ELEVATION B



PLAN 655 - CRAFTSMAN FRONT ELEVATION B

PLAN 655  
NATOMAS PARK



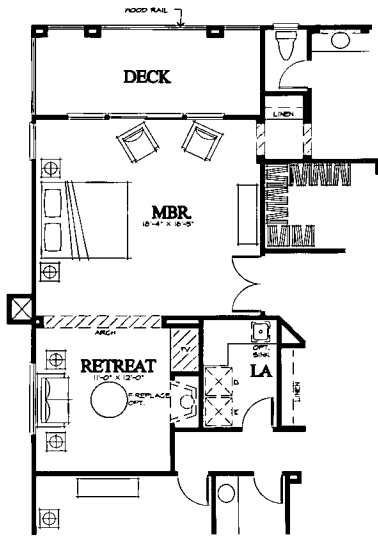
5/11/99



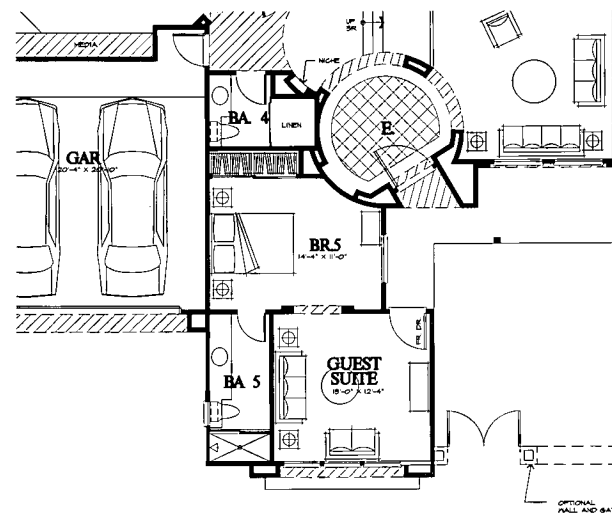
99009A



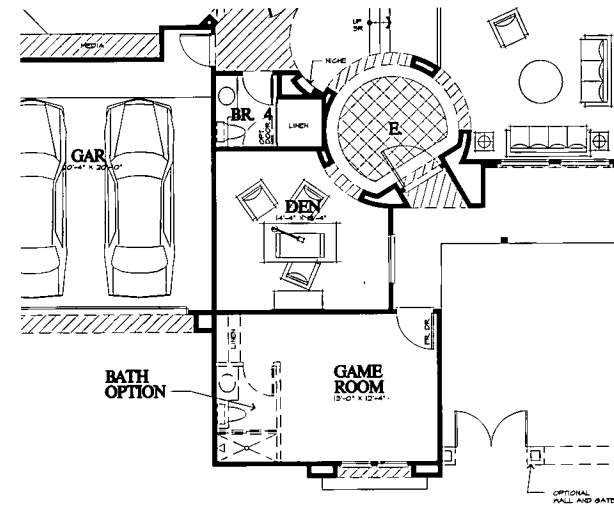
Exhibit 9c  
P99-071



PLAN 655 - OPTION 3  
RETREAT OPTION  
NO ADDITIONAL AREA

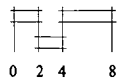


PLAN 655 - OPTION 2  
GUEST SUITE OPTION  
240 SQ. FT.



PLAN 655 - OPTION 1  
GAME ROOM OPTION  
240 SQ. FT.

PLAN 655  
OPTIONS  
NATOMAS PARK



5/11/99



99009A



Exhibit 9d  
P99-071



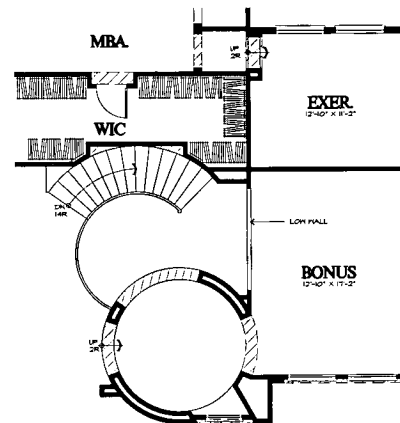
PLAN 655 - FRENCH COUNTRY FRONT ELEVATION C  
OPTION 4 & 5



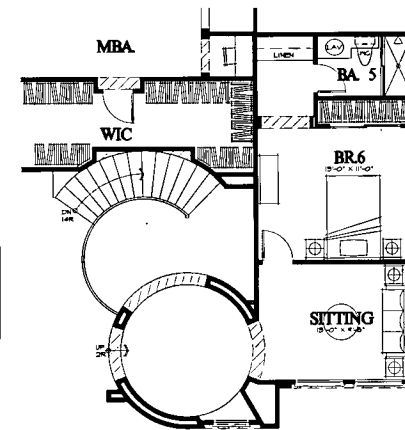
PLAN 655 - CRAFTSMAN FRONT ELEVATION B  
OPTION 4 & 5



PLAN 655 - MONTEREY FRONT ELEVATION A  
OPTION 4 & 5

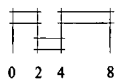


PLAN 655 - OPTION 4  
BONUS ROOM OPTION  
400 SQ. FT.



PLAN 655 - OPTION 5  
BEDROOM OPTION  
400 SQ. FT.

PLAN 655 - OPTION 4 & 5  
NATOMAS PARK



5/11/99



99009A



Exhibit 9e  
P99-071

## SCREENING AND FENCES

### A. General

All new sound walls, masonry walls or fences shall be designed to minimize visual monotony through changes in plane, height, material or material texture and/or significant landscape massing where appropriate.

#### A1. Design

All fencing should be designed as an integrated part of the site, rather than as a separate fence. The design of fencing, sound walls, trash enclosures, and similar site elements shall be compatible with the architecture of the main buildings and should use similar materials. Use of Chain link fence will not be allowed.

Figure V-1 shows the visible wing and side lot fencing detail which must be stained with a color to be determined later. In addition, any other visible fencing must be stained and capped (for example, fencing along a park or on a corner lot).

<b>NPDRC APPROVED</b>
APPROVED BY: <i>Don Barrett</i>
APPROVED DATE: <i>5/28/99</i>
COMMENTS:

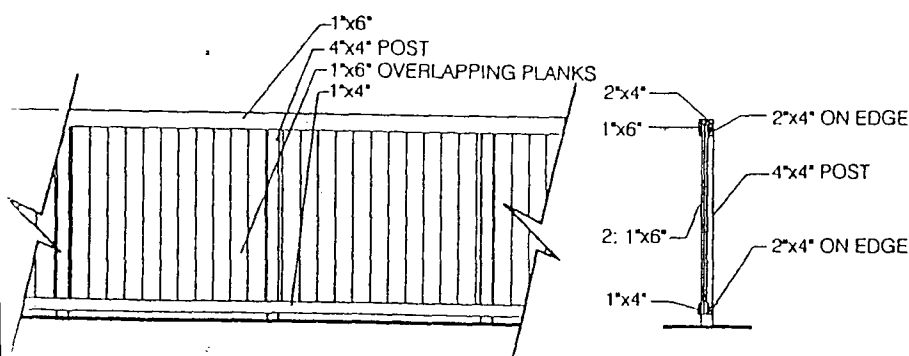


FIGURE V-1 FENCE WITH WOOD POST

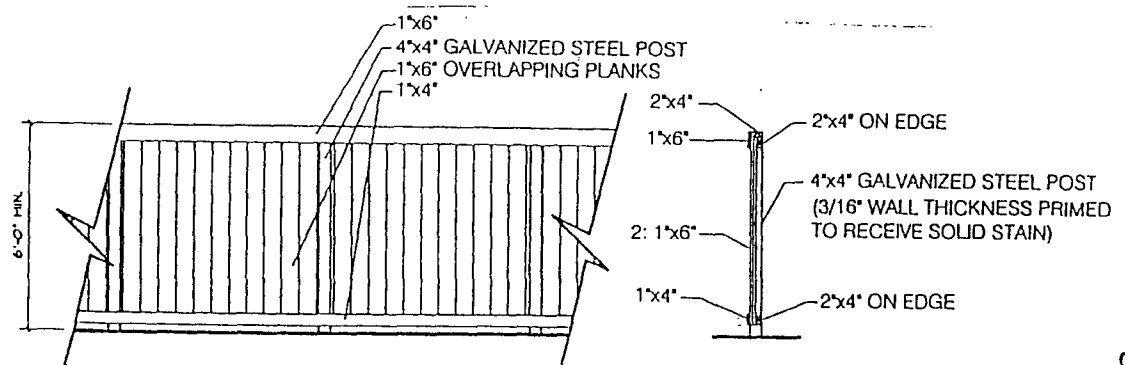


FIGURE V-2 FENCE WITH STEEL POST

Exhibit 102  
 P99-071

Natomas Park  
Single Family Residential development  
Design Review Handbook and Guideline Supplement

Furthermore, when a fence is adjacent to a park site, open space or school, galvanized steel posts shall be used in lieu of wood. This Variation is shown in Figure V-2. Refer to exhibits VI-4 and VI-5 for the location of fences with steel posts.

Where fencing ties into a Village Entry pilaster, refer to Section IX, Community Monumentation. Specific requirements for fence attachment to the pilaster is required. Figure V-3 shows how the fence must exit at a 90 degree angle to the pilaster away from the street, then take a forty-five degree angle that intersects with fencing which extends from the unit side yard building wall.

Walls shall be a minimum 6' in height comprised of a split-face concrete block unit and precast concrete cap. Color shall be a light, natural earthen color equal to Baseline #345. Color samples for the wall will be retained by the Natomas Park Design Committee for future development consistency. Block shall be a split-face finish and accented with vines placed at a regular spacing of a minimum to ten (10') feet on center. The wall cap shall be a decorative cornice type. Refer to Figure V-4 for a typical elevation. Refer to exhibits VI-4 and VI-5 for wall location.

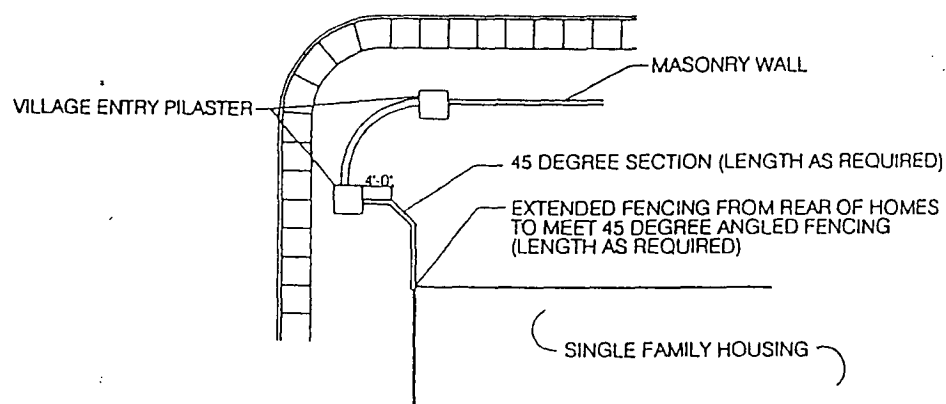


FIGURE V-3 FENCE CONNECTION TO PILASTER

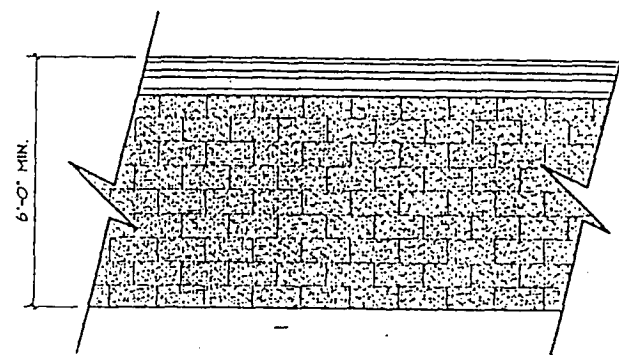


FIGURE V-4 WALL EXAMPLE

EXHIBIT 105  
P99-071

Exhibit 11a  
P99-071



June 1, 1999

Mr. Jeffrey J. Panasiti  
Director of Administration  
Lennar Renaissance, Inc.  
2240 Douglas Blvd., Suite 250  
Roseville, CA 95661

**RE: Design Review - Lennar Renaissance, Inc. - Natomas Park  
Northpointe Park Village 12**

Dear Jeff:

The plans you submitted for Northpointe Park Villages 12 have been reviewed by the Natomas Park Design Review Committee. The submitted items, listed below, are approved with the following conditions:

Floor plans & Elevations

Floor plans are approved as submitted.

Exterior elevations approved with following conditions:

1. Homes with back or sides to streets, parks, open space and schools need to continue trim along visible side of house, as noted on plans.
2. Materials shall wrap on the sides of the homes, as noted on the plans.
3. The accent materials shown on plans are to be standard materials, not options.
4. Driveways shall have a pattern of score lines that will create a pleasing texture compatible with the architecture.

In addition to these conditions, we have the following comments:

1. We recommend that any roof projections (i.e.: vents, pipes) be located in the back of the home, not visible from the street.
2. On the Plan 653 with the Monterey style elevation, we would like to suggest that you consider changing the style of window for the upper bath to the same style as the Plan 653, elevation B.
3. Please clarify the gable treatment on Plan 654, elevation B.
4. Please clarify if a door to the outside is missing from the single car garage on Plan 655.

Landscape Plans

Approved with conditions noted on plans.

Site/Lot Plans

Approved as submitted.

Exhibit 11b  
P99-071

Jeffrey J. Panasiti, 6/1/99  
Lennar Renaissance, Inc.  
Page Two

We believe that the appearance of the streetscape is a critical element in achieving an attractive community. For this reason, we request that you stagger your home setbacks to create an open and diverse streetscape.

Exterior colors and Materials

As noted in your letter dated May 28, 1999, the materials and colors notebook will be submitted to the NPDRC within the next 2-3 weeks. The NPDRC will review your exterior materials and colors upon receipt of the required information.

Please be aware that the adopted guidelines require diversity in streetscape, i.e.: variation of colors and elevations. Please provide evidence during the project development of achieving the required diversity.

Your model home complex site plan, neighborhood identification signage and/or monumentation is also subject to approval by the NPDRC. Please submit for review when available.

Your plans were reviewed for compliance with the Design Review Handbook. You are responsible to ensure that the plans are in compliance with the City of Sacramento Zoning Code and all applicable building codes. Compliance with the City of Sacramento Zoning Code includes compliance with building setback and lot coverage standards.

For your reference, please find enclosed the garage mitigation compliance form and a checklist that we used during our review. Please give me a call should you have any questions.

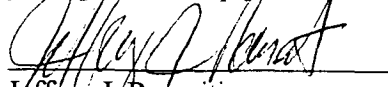
Respectfully,

LENNAR COMMUNITIES

  
Don Barnett  
Community Planning Manager

Cc: DRC file

By signing below, you acknowledge your acceptance of these comments and conditions, and you agree to comply with them.

  
Jeffrey J. Panasiti

June 2, 1999  
Date

Exhibit 11c  
P99-071

## DESIGN REVIEW CHECKLIST

BUILDER: Renaissance/Winncrest Homes  
VILLAGE: Northpointe 12

### ARCHITECTURAL ITEMS

- ok** **Porches**  
Minimum size 5 ft. deep x 8 ft. long
- Garages**  
If 3 or more cars, garage doors not in same plane  
All garage doors shall have minimum 6" recess from frame
- Roof Pitch**  
Minimum shall be 5 ft. vertical in 12 ft. horizontal
- Material Changes**  
Changes must occur at reverse corners or return on a side wall towards the privacy screen  
Side wall return shall be no less than 4 ft, unless material being used to create column effect

### LANDSCAPE ITEMS

#### FRONT YARD:

- ok** **Street Trees**  
One 15-gal per 30 linear ft. of street, 4 ft. from back of walk
- ok** **Ground Cover Edge**  
At least 3 laminated 3/8" x 4" redwood benderboard
- ok** **Ground Cover to Turf**  
2/3 front yard turf, 1/3 ground cover and shrubs
- ok** **Accent Tree**  
One per front yard, min. 15 gal.
- ok** **Specimen Shrubs**  
Min. one per front yard, min. 5 gal.
- ok** **Foundation and Accent Shrub Mix**  
Min. 20 per front yard, min. 1 gal.
- ok** **Ground Cover from Flats**  
Max. spacing 12" on center

Exhibit 11d  
P99-071

**Turf from Sod**  
Dwarf Fescue, Bluegrass Blend 95/5

**Decorative Bark**  
Required in all ground cover areas, max. size 3/4"

**SIDE YARD:**

**Accent Trees**  
Min. 3 per side yard, min. 15 gal.

**Specimen Shrub**  
Min. 1 per side yard, min. 5 gal.

**Foundation & Accent Shrub Mix**  
Min. 10 per side yard, 1 gal.

**Ground Cover**  
Max. spacing 12" on center

**Turf from Sod**  
Dwarf Fescue, Bluegrass Blend 95/5

**Decorative Bark**  
Max. size 3/4"

**SITE/LOT PLAN ITEMS**

**SETBACKS:**

**Porch**  
Min. 14 ft. from front property line

**Front of Building**  
Min. 16 ft. from front property line, excluding porch

**Side Yard**  
Min. 5 ft. on each side (Bay windows, fireplaces, etc. may encroach 2 ft.)  
Min 10 ft. sideyard yard setback adjacent to street

**Rear Yard**  
Min. 15 ft.

**Garage**  
Min. 20 ft. from property line for front or street side driveways  
Min. 16 ft. from property line for side entry garages

Exhibit 11e  
P99-071

**Projections and Bays**

Can encroach up to 3 ft. into front yard building setback  
Can encroach up to 2 ft. into side yard building setback  
Not allowed within the min. 14 ft. setback.

**Screening and Fences**

Fences adjacent to park site, open space or school - galvanized steel posts  
Fence attachment to pilasters on corners: 90 degree, then 45 degree to fence extended from house

**EXTERIOR MATERIALS & COLORS**

PLEASE SUBMIT WHEN AVAILABLE

- Exterior colors
- Exterior materials
- Roof tile samples

**CONTRACT SQUARE FOOTAGES**

All plans within contract square footage guidelines

**ADDITIONAL APPROVAL LETTER ITEMS:**

- XXX List submittal items still needed
- Garage mitigation needed, if any
- XXX Homes with back or side to streets need to continue trim along visible side of house
- XXX Wall and fence conditions, if any
- XXX Driveway surface shall have pattern of score lines to create pleasing texture
- XXX Confirm that accent materials shown (i.e.: shutters, columns, trim, siding, etc.) are standard, not options

Exhibit 11f  
P99-071

### GARAGE MITIGATION COMPLIANCE

BUILDER/NEIGHBORHOOD: Northpointe 12

% compliance  
of total  
# of homes

PLAN	ELEVATION A	B	C	D	
652	Porch and living area option, plus courtyard option (2/3 credit)	Porch and living area option, plus courtyard option (2/3 credit)	Living area option (2/3 credit)		16%
653	Porch and living area option  (full credit)	Porch and living area option  (full credit)	Living area option  (full credit)		25%
654	Living area forward  (full credit)	Living area forward  (full credit)	Living area option  (full credit)		25%
655	Living area option plus courtyard option  (2/3 credit)	Living area option plus courtyard option  (2/3 credit)	Living area option, plus courtyard option  (2/3 credit)		16%

TOTAL COMPLIANCE %:

83%