

CITY OF SACRAMENTO

Permit No: 0211780

1231 I Street, Sacramento, CA 95814

Insp Area: 2

Thos Bros: 337 B4

Site Address: 7676 RIVER RANCH WY SAC

Sub-Type: RES

Parcel No: 031-0540-025

Housing (Y/N): N

CONTRACTOR

ZIMMERMAN REROOFING CO.
3675 R ST.
SACRAMENTO, CA. 95816

OWNER

RITTELL J ANTHONY/VICTORIA I.
7676 RIVER RANCH WY
SACRAMENTO CA 95831

ARCHITECT

Nature of Work: T/O & RROOF W/TILE 39 SQS 1 STORY

CONSTRUCTION LENDING AGENCY: I hereby affirm under penalty of perjury that there is a construction lending agency for the performance of the work for which this permit is issued (Sec. 3097, Civ. C).

Lender's Name Lender's Address

LICENSED CONTRACTORS DECLARATION: I hereby affirm under penalty of perjury that I am licensed under provisions of Chapter 9 (commencing with section 7000) of Division 3 of the Business and Professions Code and my license is in full force and effect.

License Class 39 License Number 763169 Date 9-3-02 Contractor Signature Alma Gonzalez

OWNER-BUILDER DECLARATION: I hereby affirm under penalty of perjury that I am exempt from the contractors License Law for the following reason (Sec. 7031.5, Business and Professions Code; any city or county which requires a permit to construct, alter, improve, demolish, or repair any structure, prior to its issuance, also requires the applicant for such permit to file a signed statement that he or she is licensed pursuant to the provisions of the Contractors License Law (Chapter 9 (commencing with Section 7000) of Division 8 of the Business and Professions Code) or that he or she is exempt therefrom and the basis for the alleged exemption. Any violation of Section 7031.5 by any applicant for a permit subjects the applicant to a civil penalty of not more than five hundred dollars (\$500.00);

I, as a owner of the property, or my employees with wages as their sole compensation, will do the work, and the structure is not intended or offered for sale (Sec. 7044, Business and Professional Code: The Contractors License Law does not apply to an owner of property who builds or improves thereon, and who does such work himself or herself or through his/her own employees, provided that such improvements are not intended or offered for sale. If, however, the building or improvement is sold within one year of completion, the owner-builder will have the burden of proving that he/she did not build or improve for the purpose of sale.)

I, as owner of the property, am exclusively contracting with licensed contractors to construct the project (Sec. 7044, Business and Professions Code: The Contractors License Law does not apply to an owner of property who builds or improves thereon, and who contracts for such projects with a contractor(s) licensed pursuant to the Contractors License Law).

I am exempt under Sec. B & PC for this reason: Date Owner Signature

IN ISSUING THIS BUILDING PERMIT, the applicant represents, and the city relies on the representation that the applicant has verified all measurements and locations shown on the application or accompanying drawings and that the improvement to be constructed does not violate any law or private agreement relating to permissible or prohibited locations for such improvements. This building permit does not authorize any illegal location of any improvement or the violation of any private agreement relating to location of improvements.

I certify that I have read this application and state that all information is correct. I agree to comply with all city and county ordinances and state laws relating to building construction and hereby authorize representative(s) of this city to enter upon the abovementioned property for inspection purposes.

Date 9-3-02 Applicant/Agent Signature Alma Gonzalez

WORKER'S COMPENSATION DECLARATION: I hereby affirm under penalty of perjury one of the following declarations:

I have and will maintain a certificate of consent to self-insure for workers' compensation as provided for by Section 3700 of the Labor Code, for the performance of work for which the permit is issued.

I have and will maintain workers' compensation insurance, as required by Section 3700 of the Labor Code, for the performance of the work for which this permit is issued. My workers' compensation insurance carrier and policy number are:

Carrier STATE FUND Policy Number 713-01 UNIT 0002021 Exp Date 10/01/2002

(This section need not be completed if the permit is for \$100 or less) I certify that in the performance of the work for which this permit is issued, I shall not employ any person in any manner so as to become subject to the workers' compensation laws of California and agree that if I should become subject to the workers' compensation provisions of Section 3700 of the Labor Code, I shall forthwith comply with those provisions.

Date 9-3-02 Applicant Signature Alma Gonzalez

WARNING: FAILURE TO SECURE WORKER'S COMPENSATION COVERAGE IS UNLAWFUL AND SHALL SUBJECT AN EMPLOYER TO CRIMINAL PENALTIES AND CIVIL FINES UP TO ONE HUNDRED THOUSAND DOLLARS (\$100,000) IN ADDITION TO THE COST OF COMPENSATION, DAMAGES AS PROVIDED FOR IN SECTION 3706 OF THE LABOR CODE, INTEREST AND ATTORNEY'S FEE.

THIS PERMIT SHALL EXPIRE BY LIMITATION IF WORK IS NOT COMMENCED WITHIN 180 DAYS.

R

Paul Zacher - Structural Engineers  
4701 Lakeside Way  
Fair Oaks, CA 95628

This set of plans and specifications must be kept on the job at all times and it is unlawful to make any changes or alterations from the set of plans and specifications without the

TEL: 916.961.3960  
FAX: 916.961.6552

August 22, 2002

Zimmerman Roofing  
3675 R Street  
Sacramento, CA 95816  
TEL: (916) 454-3667  
FAX: (916) 691-1943

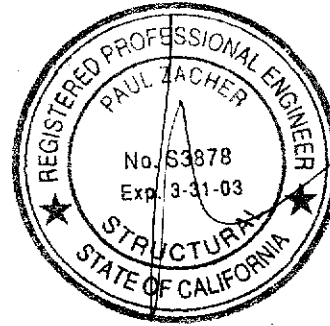
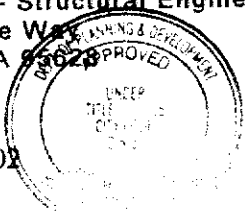

*See R 8/27/02  
see details sht. 6,  
Recommendation sht 2*

Attn.: Mr. Jeff Tucker, *DO NOT LOOK PRIOR TO INSPECTIONS*  
re: Job 2002331: LEE-RITTEL

Subject: Structural Investigation Report of the Roof for the Residence located at 7676 River Ranch Way, Sacramento, CA 95831.

As requested by Mr. Jeff Tucker, this is a report to determine what needs should be addressed to correct any structural deficiencies of the roof. Paul Zacher visited the site August 22, 2002. The investigation was made to determine the existing condition of the structure. All information, data and analysis contained within this report are based on the 1997 Uniform Building Code.

The following is based on visual observations with no subsurface investigation being made.

**DESCRIPTION:**

Type of Facility: Residence.  
Year Built: Estimated 1980's vintage.  
Occupancy: Residential.  
No. of Stories: One.  
Dimensions: Approximately 2000 square feet.

**CONSTRUCTION:**

Roof:  
The roof covering will consist of a Light Weight Concrete Tile over 1/2" solid sheathing. The roof structure is conventionally framed with 2x6 rafters spaced at 24" on center with 2x6 purlins supported at no more than 6'-0" on center by 2x4 struts bearing on walls below. The garage area is framed with 2x6 rafters spaced at 24" on center and 2x8 cross ties spaced at 4'-0" on center.

**CONCLUSIONS:**

Roof:  
The roof structure currently lacks sufficient structural capacity for the applied live and dead loads. See "Recommendations" for location and repair to bring the roof structure up to the required capacity.

P  
R  
E  
P  
A  
R  
E  
D  
B  
Y  
S  
T  
R  
U  
C  
T  
U  
R  
A  
L  
E  
N  
G  
I  
N  
E  
E  
R  
S  
P  
A  
U  
L  
Z  
A  
C  
H  
E  
R  
E  
N  
G  
I  
N  
E  
E  
R  
S



Paul Zacher - Structural Engineers  
4701 Lakeside Way  
Fair Oaks, CA 95628

TEL: 916.961.3960  
FAX: 916.961.6552

RECOMMENDATIONS:

If any of the following recommendations do not correspond to actual field conditions, the engineer of record shall be notified for further investigation and evaluation before continuing work.

Roof Structure:

1. Scab a 2x6 rafter to the existing 2x6 rafters with 16d's @ 12" on center where the span is greater than 12'-0". See detail 1.
2. Provide additional 2x4 struts from the existing purlins to the bearing walls below. The maximum spacing between the new and existing struts shall not exceed 6'-0" on center. The unbraced length of the struts shall not exceed 8'-0" and the minimum slope of the struts shall not be less than 45 degrees from the horizontal. See detail 1.

It shall be noted that small hairline cracking may occur at exterior stucco and interior gypboard finished walls that are load bearing or distributing roof strut loads. These cracks are a natural occurrence as the existing structure re-distributes the new roof weight. They are cosmetic in nature and are not an indication of a structural hazard or failure.

It shall be noted that some deflection of the rafters may be evident after installation of the tile. The existing roof framing has deflected but this may not be readily evident due to the uneven nature of the existing roofing material. Concrete tile is a very consistent and uniform product and when installed in an even plane, even small deflections can become apparent. This is only a cosmetic issue and not a structural concern.

The inspection consisted of visual observation only, made solely to determine the structural capacity of the existing roof. Analysis does not determine any effects on the overall structure under lateral forces or effects on the foundation unless specifically noted in the calculations and in this document. No warranties, expressed or implied, are made or intended in conjunction with this report. The inspection was made only to the portions that were accessible. The specific items noted were those that were observable and there may be defects that are not observable, or are hidden by architectural and structural materials.

If you have any questions on the above, do not hesitate to call.

Sincerely,

  
Paul Zacher, P.E., S.E.  
file

**DESIGN LOADING:**

Roof Pitch	6	in 12
Pitch Adjustment Factor	1.12	

**LOCATION: ROOF**

<u>MATERIAL</u>	<u>WEIGHT</u>	
Light Weight Tile	7.30	psf
Roofing felt	0.30	psf
1x4 skip sht'g	1.09	psf
1/2" OSB/ plywood	1.50	psf
2x6 rafters @ 24" oc	<u>1.00</u>	psf
	Load	11.2 psf
Roof Pitch Adjustment	<u>1.32</u>	psf
Total Load	12.5	psf

Job #: 02-1111

Date: 8/22/02

LOADING:

RAFTER

Dr = 12.5 pcf  $\times$  2' = 25 pLF

Lr = 16.0'  $\times$  1.5625 = 25.0 pLF

2 x 6 #2

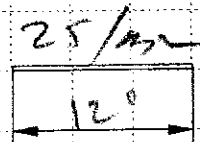

RAFTER

Dr = 12.5 pcf  $\times$  2' = 25 pLF

Lr = 16.0'  $\times$  1.5625 = 25.0 pLF

2 x 2 x 6 #2

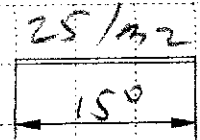

#27

Dr = 12.5 pcf  $\times$  7' = 87.5 pLF

Lr = 16.0'  $\times$  1.125 = 18.0 pLF

4 x 12 #2

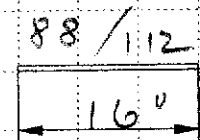

Dr =

Lr =

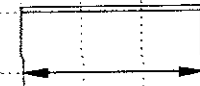

Dr =

Lr =

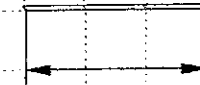

Dr =

Lr =



Dr =

Lr =



Paul Zacher - Structural Engineers  
 4701 Lakeside Way  
 Fair Oaks  
 TEL: (916) 961-3960  
 FAX: (916) 961-6552

Title :  
 Dsgnr:  
 Description :

Job #  
 Date: 5:41PM, 22 AUG 02

Scope :

Rev: 510394  
 User: KW-0602844, Ver 5.1.3, 22-Jun-1999, Win32  
 (c) 1983-99 EMERCALC

### Timber Beam & Joist

c:\emercalc\test.ecw:Calculations

Description RAFTERS AND BEAMS

#### Timber Member Information

Calculations are designed to 1997 NDS and 1997 UBC Requirements

Timber Section		rafter 2x6	rafter 2-2x6	B1 4x12	6x14
Beam Width	in	1.500	3.000	3.500	0.000
Beam Depth	in	5.500	5.500	11.250	0.000
Le: Unbraced Length	ft	0.00	0.00	0.00	0.00
Timber Grade		Douglas Fir - Larch	Douglas Fir - Larch	Douglas Fir - Larch	
Fb - Basic Allow	psi	875.0	875.0	875.0	0.0
Fv - Basic Allow	psi	95.0	95.0	95.0	0.0
Elastic Modulus	ksi	1,600.0	1,600.0	1,600.0	0.0
Load Duration Factor		1.250	1.250	1.250	0.000
Member Type		Sawn	Sawn	Sawn	Manuf/Pine
Repetitive Status		Repetitive	Repetitive	No	No

#### Center Span Data

Span	ft	12.00	15.00	16.00	11.50
Dead Load	#/ft	25.00	25.00	88.00	
Live Load	#/ft	32.00	32.00	112.00	

#### Results

Ratio = 0.9956 0.7778 0.8646 0.0000

Mmax @ Center	in-k	12.31	19.24	76.80	0.00
@ X =	ft	6.00	7.50	8.00	0.00
Fb : Actual	psi	1,628.0	1,271.9	1,040.3	0.0
Fb : Allowable	psi	1,635.2	1,635.2	1,203.1	0.0
		<b>Bending OK</b>	<b>Bending OK</b>	<b>Bending OK</b>	<b>Bending OK</b>
Fv : Actual	psi	57.7	36.7	54.1	0.0
Fv : Allowable	psi	118.8	118.8	118.8	0.0
		<b>Shear OK</b>	<b>Shear OK</b>	<b>Shear OK</b>	<b>Shear OK</b>

#### Reactions

@ Left End	DL	lbs	150.00	187.50	704.00	0.00
	LL	lbs	192.00	240.00	896.00	0.00
	Max. DL+LL	lbs	342.00	427.50	1,600.00	0.00
@ Right End	DL	lbs	150.00	187.50	704.00	0.00
	LL	lbs	192.00	240.00	896.00	0.00
	Max. DL+LL	lbs	342.00	427.50	1,600.00	0.00

#### Deflections

Ratio OK Deflection OK Deflection OK Deflection OK

Center DL Defl	in	-0.351	-0.428	-0.195	0.000
L/Defl Ratio		410.8	420.7	983.2	0.0
Center LL Defl	in	-0.449	-0.548	-0.249	0.000
L/Defl Ratio		320.9	328.7	772.5	0.0
Center Total Defl	in	-0.799	-0.976	-0.444	0.000
Location	ft	6.000	7.500	8.000	0.000
L/Defl Ratio		180.2	184.5	432.6	0.0

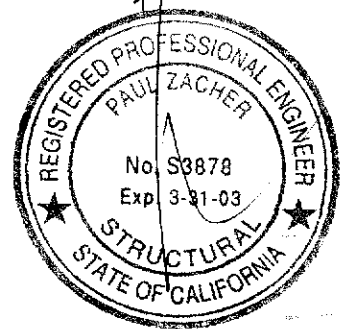
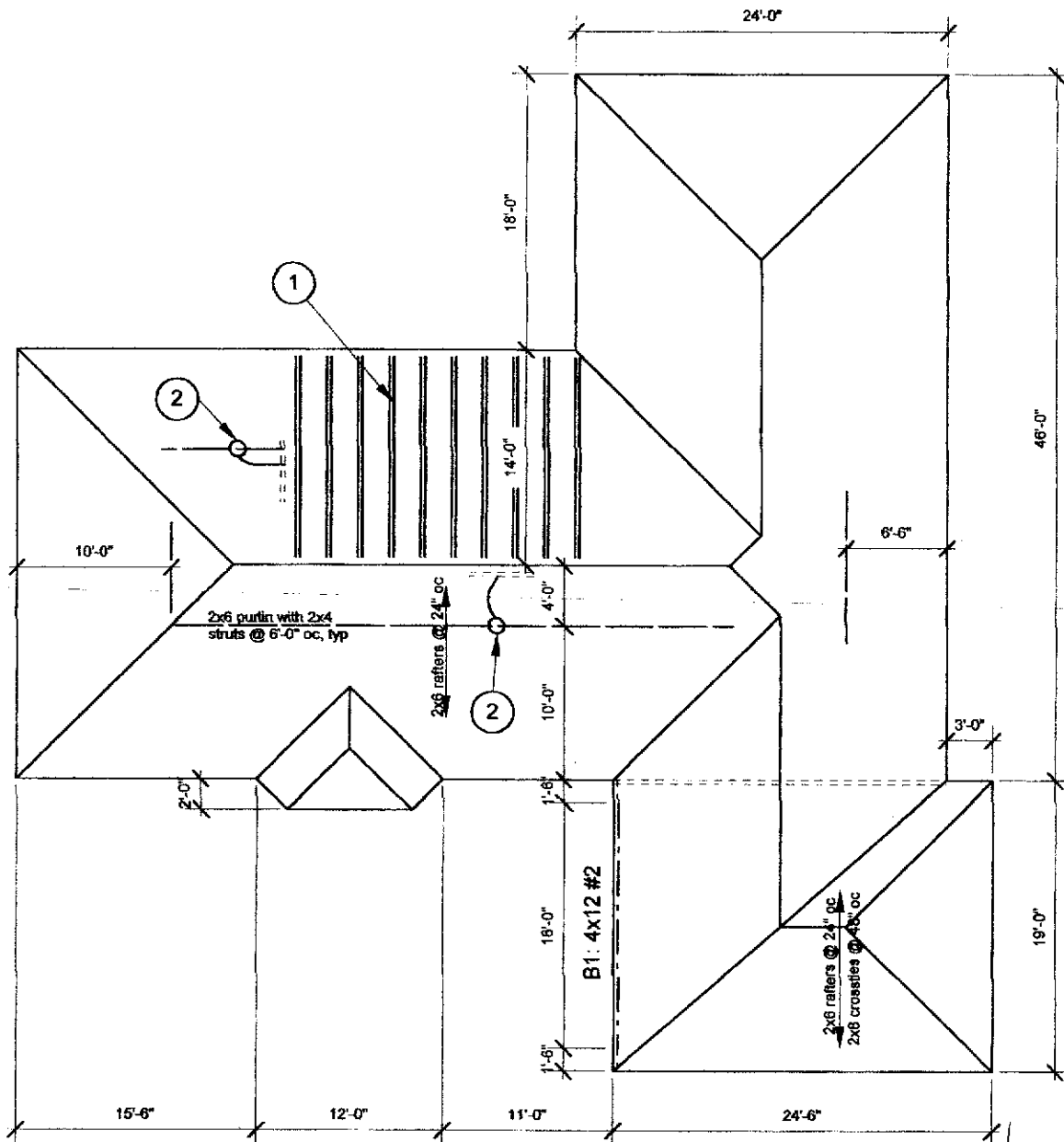

**FRAMING NOTES:**

1. Scab a 2x6 to existing 2x6 rafters where the span is greater than 12'-0" (total 10).
2. Add 2x4 struts to bearing below (total 2).

**Notes:**

- A. This is a reroof project. The new roofing material shall be a Light Weight Concrete Tile. The tile shall weigh less than or equal to 7.3 psf.
- B. All rafters are 2x6 DF#2 and hips and valleys are 2x8 DF#2 unless otherwise noted.
- C. All existing rafter, hips, valleys, rafter ties, and purlins are braced per UBC Section 2320.1 "Roof and Ceiling Framing" unless otherwise shown.
- D. All structural wood members that were observed appear to be in sound condition and without structural defect.



**ROOF PLAN - LEE-RITTEL**

Not to Scale

6