



REPORT TO COUNCIL

City of Sacramento

915 I Street, Sacramento, CA 95814-2671
www. CityofSacramento.org

CONSENT
April 17, 2007

Honorable Mayor and
Members of the City Council

Title: Taylor Street Cottages (P06-142)

Location/Council District: West side of the 4000 block of Taylor Street
APN: 237-0180-012 & -053 (District 2)

Recommendation: 1) Review a **Resolution** adopting a Mitigated Negative Declaration and Mitigation Monitoring Plan; 2) Review a **Resolution** adopting an Inclusionary Housing Plan; 3) Review an **Ordinance** amending the Comprehensive Zoning Ordinance (Title 17 of the Sacramento City Code); and 4) Pass for publication the **Ordinance** title as required by the Sacramento City Charter 32c to be adopted April 26, 2007.

Contact: Stephen Kowalski, Associate Planner, (916) 808-4752; Stacia Cosgrove, Senior Planner, (916) 808-7110

Presenter: Not Applicable

Department: Development Services

Division: Current Planning

Organization No.: 4881

Description/Analysis:

Issue: The applicant is requesting to rezone the subject property from Agricultural (A) to Single-Family Alternative (R-1A) to allow the development of a 77-lot single-family residential subdivision containing 73 single-family lots and 4 landscape lots. The project is subject to the Mixed Income Housing Ordinance and features an Inclusionary Housing Plan requiring 11 of the units (or 15% of the total number) to be affordable to Low Income and Very Low Income households (see Exhibit A of Attachment 24). The project is not controversial and has the support of staff.

Policy Considerations: The project is consistent with the General Plan and North Sacramento Community Plan, both of which designate the site for medium density residential development. The proposed rezone will make the zoning of the property consistent with the land use designations of the General Plan and

North Sacramento Community Plan.

The site is designated Medium Density Residential (16-29 dwelling units per net acre) in the Land Use Element of the General Plan, while the proposed density of the subdivision is only 15 dwelling units per net acre. However, the proposed density is consistent with the North Sacramento Community Plan which prescribes a range of 11-21 dwelling units per net acre for the site, and Table 2 of Section 9 of the General Plan (Community Plan/General Plan Land Use Matrix, p. 9-9) defines this Community Plan land use designation as being consistent with the Medium Density Residential designation of the General Plan.

Smart Growth Principles: The City Council adopted a set of Smart Growth Principles in December 2001 to promote growth that is economically sound, environmentally friendly, and supportive of community livability. The subject proposal is consistent with these principles in that it helps provide a range of affordable housing opportunities, concentrates new medium-density residential development on an underutilized site in close proximity to existing neighborhood-serving commercial uses and Interstate 80, and adds new housing stock to an older neighborhood where adequate infrastructure is already in place.

Strategic Plan Implementation: The project conforms to the City of Sacramento's Strategic Plan specifically by advancing the goals to achieve sustainability and enhance livability by providing new homes in an area already served by existing infrastructure and in close proximity to existing neighborhood commercial centers and Interstate 80. It also provides increased opportunities for residents, including Low Income and Very Low Income households, to purchase and live in new, safe and affordable housing.

Committee/Commission Action: On March 22, 2007, by a unanimous vote of 9-0, the Planning Commission approved the associated Tentative Map, Special Permit and Variance entitlements subject to conditions, and forwarded the Rezone, Mitigated Negative Declaration, and Mitigation Monitoring Plan to the City Council with a recommendation for approval.

The Commission forwarded the Inclusionary Housing Plan to the Council with a recommendation that the Council require the two 4-bedroom affordable units to have 2-car garages instead of single-car garages. The Inclusionary Housing Plan approved by the Sacramento Housing and Redevelopment Agency required the developer to provide two 4-bedroom affordable units as part of the project, and allowed these two units to have only a one-car garage each. The developer will be offering a 4-bedroom houseplan featuring a 2-car garage as one of its market rate products in the subdivision, therefore the Commission felt that all of the homes in the development having 4 bedrooms should come with a 2-car garage, regardless of whether they are affordable or sold at market rate.

Environmental Considerations: A Mitigated Negative Declaration (MND) has been prepared for the project. In compliance with Section 15070(B)1 of the California Environmental Quality Act (CEQA) Guidelines, the applicant has

incorporated mandatory mitigation measures into the project plans to avoid identified environmental impacts or to mitigate such impacts to a point where it is clear that they will have no significant effect on the environment. These mitigation measures address Biological and Cultural Resources, Energy, Hazardous Materials, Hydrology and Noise. The mitigation measures are listed in the attached Mitigation Monitoring Plan (see Exhibit A of Attachment 23).

The MND was made available for a 20-day public review period from February 21, 2007 through March 12, 2007 in accordance with the applicable CEQA Guidelines. The only agency to comment on the document was the United States Army Corps of Engineers. The Corps asked that the MND reflect that it needed to verify that the isolated wetland identified by the applicant's biological consultant was not under the Corps' jurisdiction. A mitigation measure was subsequently added to the MND requiring that the isolated wetland be protected in case the Corps determined that the wetland was under its jurisdiction.

Rationale for Recommendation: The project is consistent with the policies and objectives of the General Plan and North Sacramento Community Plan, and there has been no neighborhood opposition toward the proposal throughout the review process. Mitigation measures agreed to by the applicant have been incorporated to address potentially significant impacts to cultural and biological resources, and to ensure that noise from nearby Interstate 80 does not impact the lots adjacent to the freeway. For these reasons, staff recommends that the Council approve the Ordinance to rezone the property as proposed and approve the Resolutions adopting the Inclusionary Housing Plan and the Mitigated Negative Declaration and Mitigation Monitoring Plan.

Financial Considerations: This project has no fiscal considerations.

Emerging Small Business Development (ESBD): No goods or services are being purchased under this report.

Respectfully submitted by:  _____
David Kwong
Planning Manager

Approved by:  _____
William Thomas
Director of Development Services

Recommendation Approved:

for 

 RAY KERRIDGE
 City Manager

Table of Contents:

Staff Report	Pg 1
Attachments	
1. Background Information	Pg 5
2. Vicinity Map	Pg 6
3. Land Use & Zoning Map	Pg 7
4. Tentative Map	Pg 8
5. House Fit/On-Street Parking Exhibit	Pg 9
6. Front Yard Typical Planting Plan (Plan 1)	Pg 10
7. Front Yard Typical Planting Plan (Plan 2)	Pg 11
8. Front Yard Typical Planting Plan (Plan 3)	Pg 12
9. Front Yard Typical Planting Plan (Plan 4)	Pg 13
10. Typical Plot Plan/Streetscape	Pg 14
11. Plan 1 Front Elevations	Pg 15
12. Plan 1 Side/Rear Elevations	Pg 16
13. Plan 1 Floorplans	Pg 17
14. Plan 2 Front Elevations	Pg 18
15. Plan 2 Side/Rear Elevations	Pg 19
16. Plan 2 Floorplans	Pg 20
17. Plan 3 Front Elevations	Pg 21
18. Plan 3 Side/Rear Elevations	Pg 22
19. Plan 3 Floorplans	Pg 23
20. Plan 4 Front Elevations	Pg 24
21. Plan 4 Side/Rear Elevations	Pg 25
22. Plan 4 Floorplans	Pg 26
23. Resolution – Mitigated Negative Declaration & Mitigation Monitoring Plan	Pg 27
Exhibit A – Mitigation Monitoring Plan	Pg 29
24. Resolution – Inclusionary Housing Plan	Pg 42
Exhibit A – Inclusionary Housing Plan	Pg 43
25. Ordinance – Rezone	Pg 49
Exhibit A – Rezone	Pg 50

Attachment 1 – Background Information

There is no record of any prior planning applications affecting these four parcels.

The applicant is proposing to rezone 6.79± acres of vacant land from Agricultural (A) to Single-Family Alternative (R-1A) and develop a 77-lot single-family subdivision on the western side of Taylor Street south of Jessie Avenue and north of Interstate 80. Seventy-three of the lots will contain detached single-family dwellings, while the other four will serve as landscape parcels. The subdivision features an average lot size of 2,600± square feet and a proposed density of 15 dwelling units per net acre. Three new 41-foot wide public rights-of-way will loop through the subdivision and connect out to Taylor Street to the east. Home sizes will range from 1,350± to 1,730± square feet each and feature 3 or 4 bedrooms, 2 ½ bathrooms, and 1-car or 2-car garages. In accordance with the Inclusionary Housing Plan, the developer will be required to provide 11 for-sale affordable units in the subdivision. Seven of these will be affordable to Very Low Income households, and four will be affordable to Low Income households.

Attachment 2 - Vicinity Map

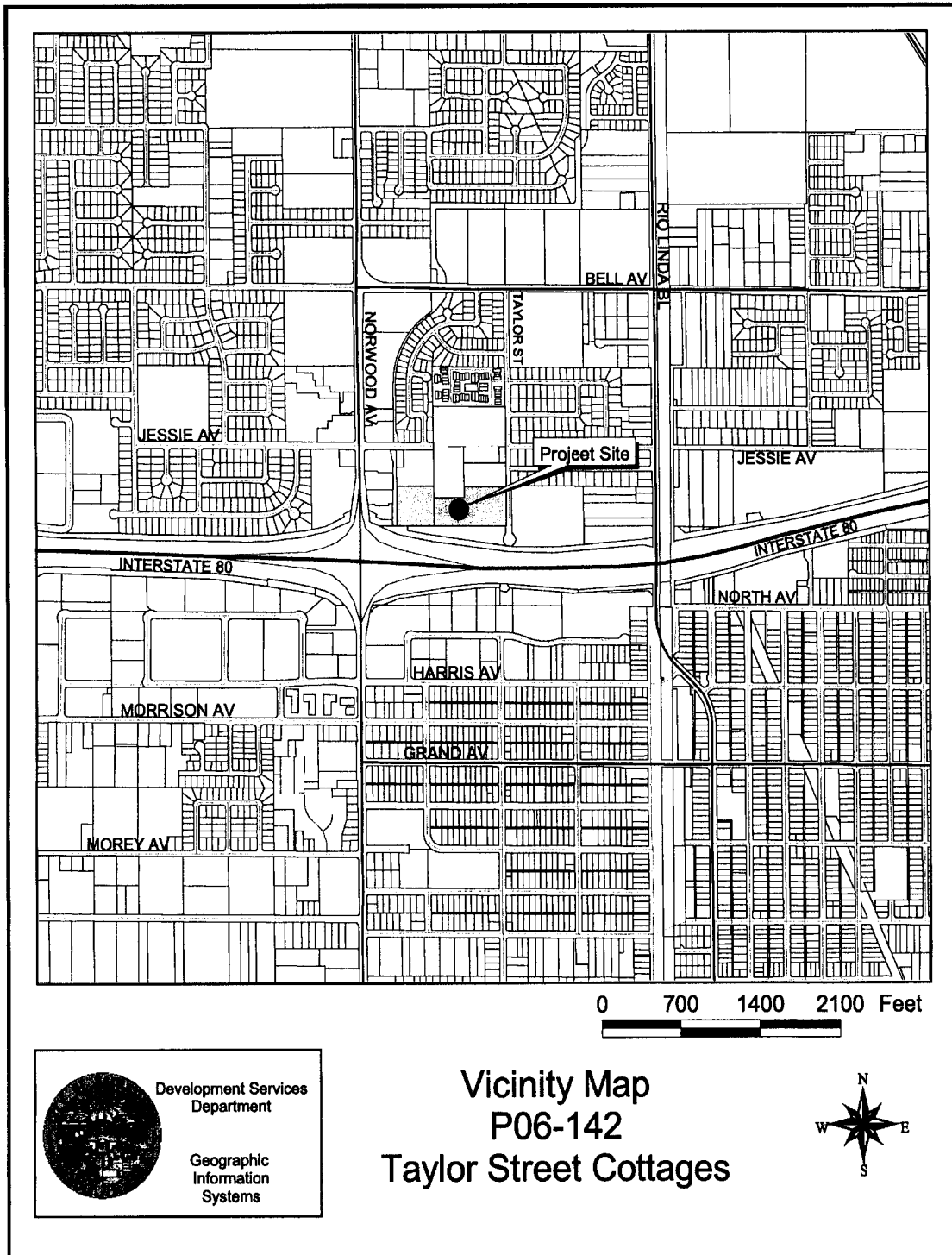

Attachment 3 – Land Use & Zoning Map

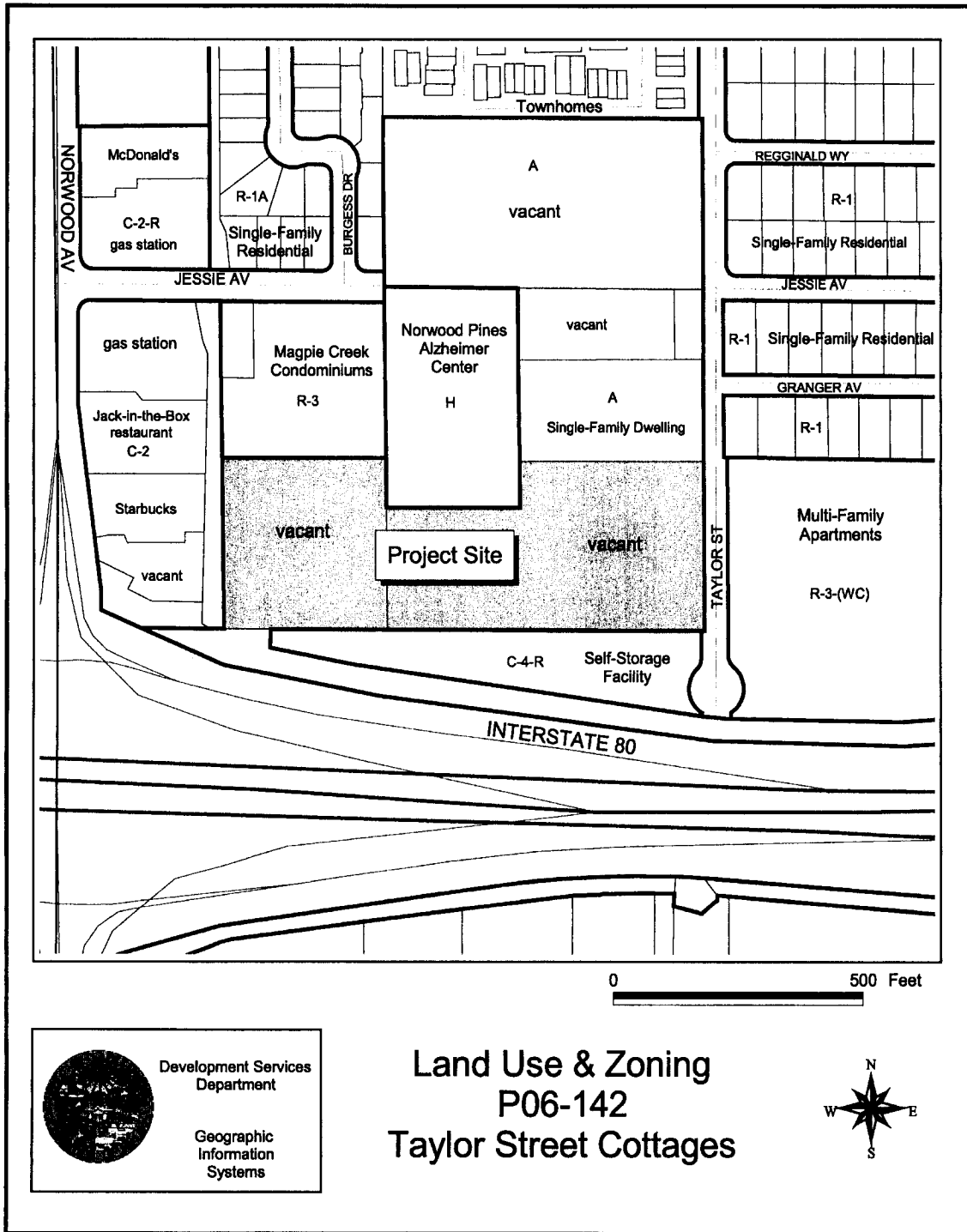

Attachment 5 – House Fit/On-Street Parking Exhibit

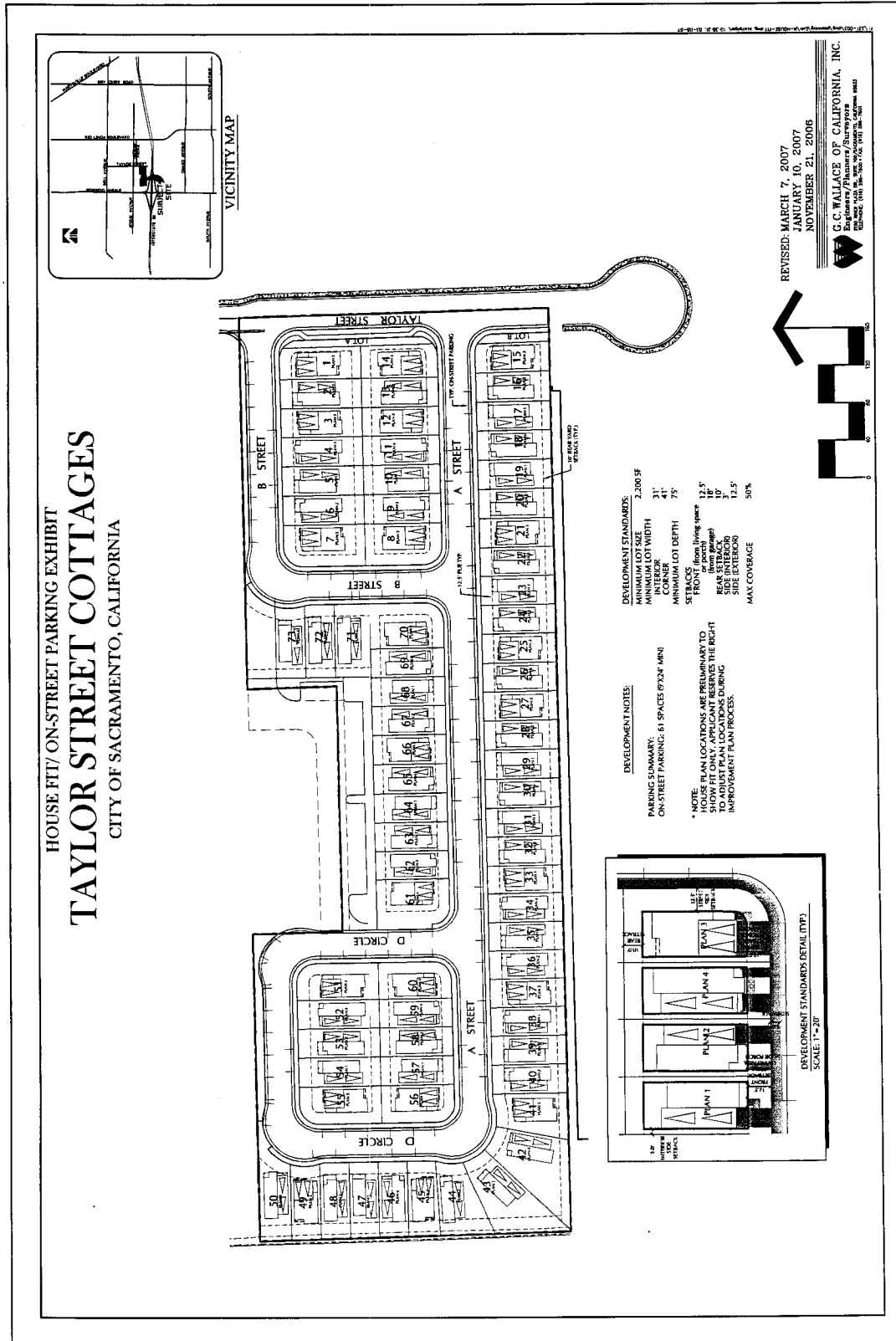

Attachment 6 – Front Yard Typical Planting Plan (Plan 1)

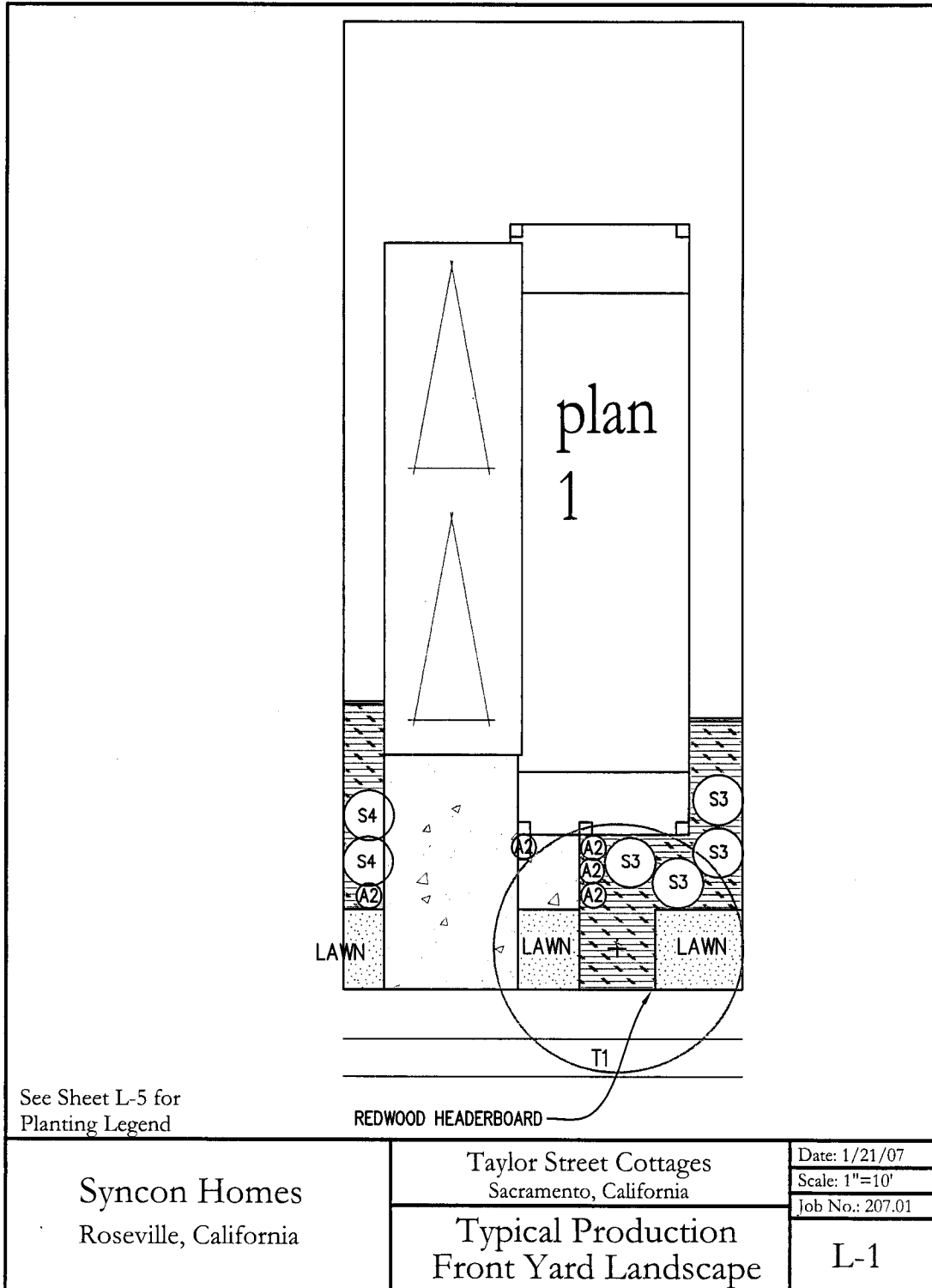

See Sheet L-5 for
Planting Legend

Syncon Homes Roseville, California	Taylor Street Cottages Sacramento, California	Date: 1/21/07
	Typical Production Front Yard Landscape	Scale: 1"=10'
		Job No.: 207.01
		L-1

Attachment 7 – Front Yard Typical Planting Plan (Plan 2)

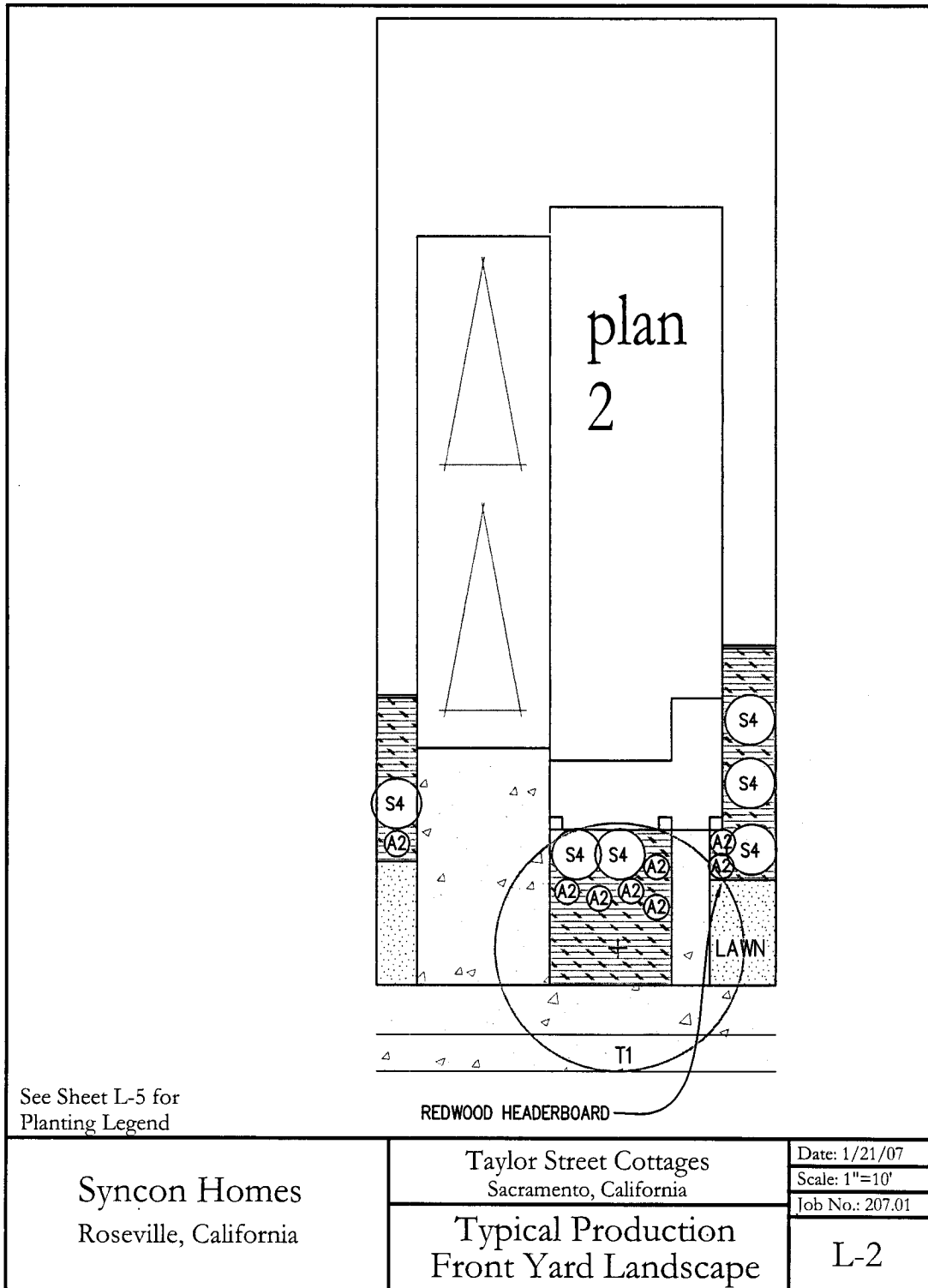

Attachment 8 – Front Yard Typical Planting Plan (Plan 3)

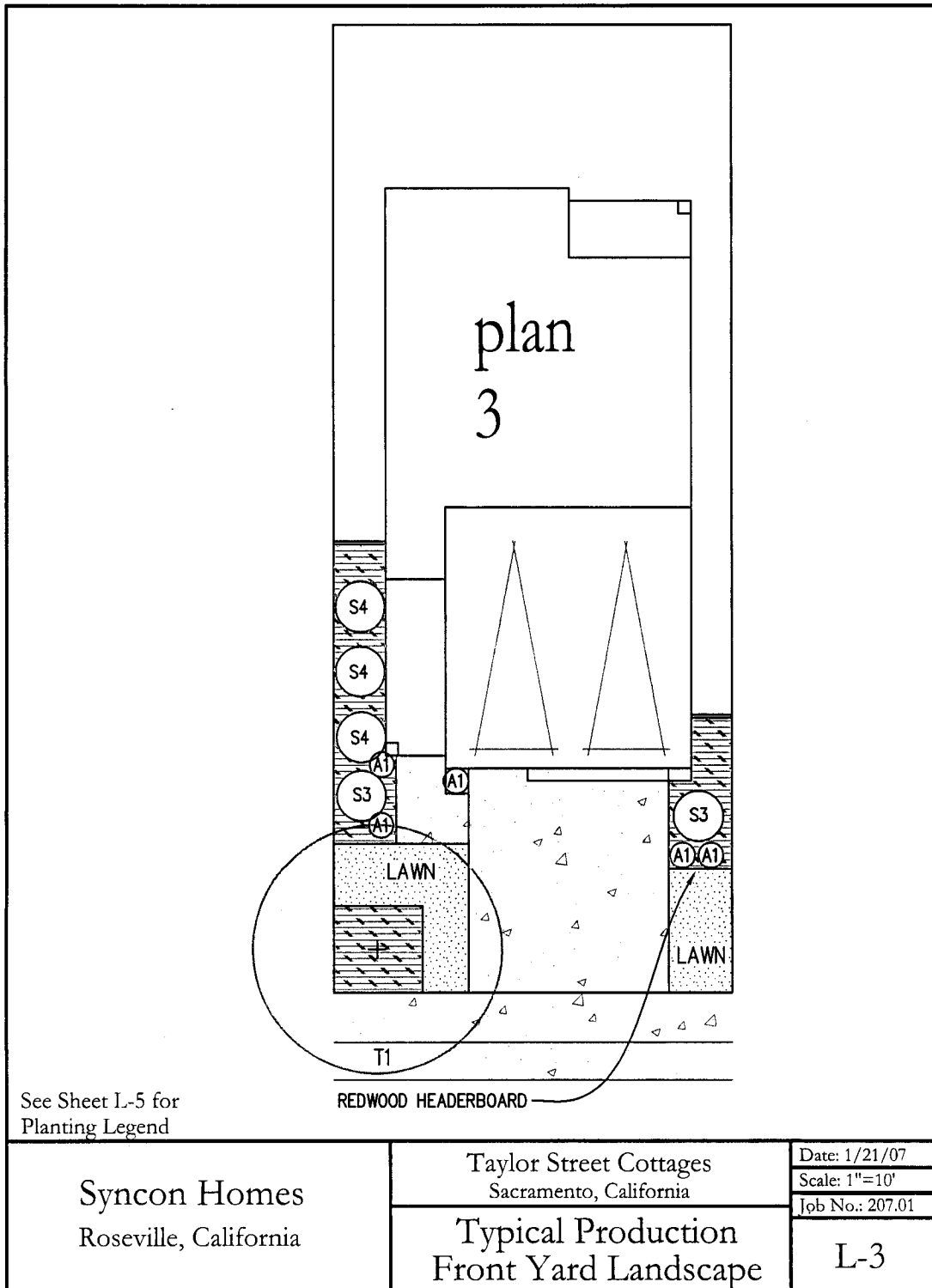

Attachment 9 – Front Yard Typical Planting Plan (Plan 4)

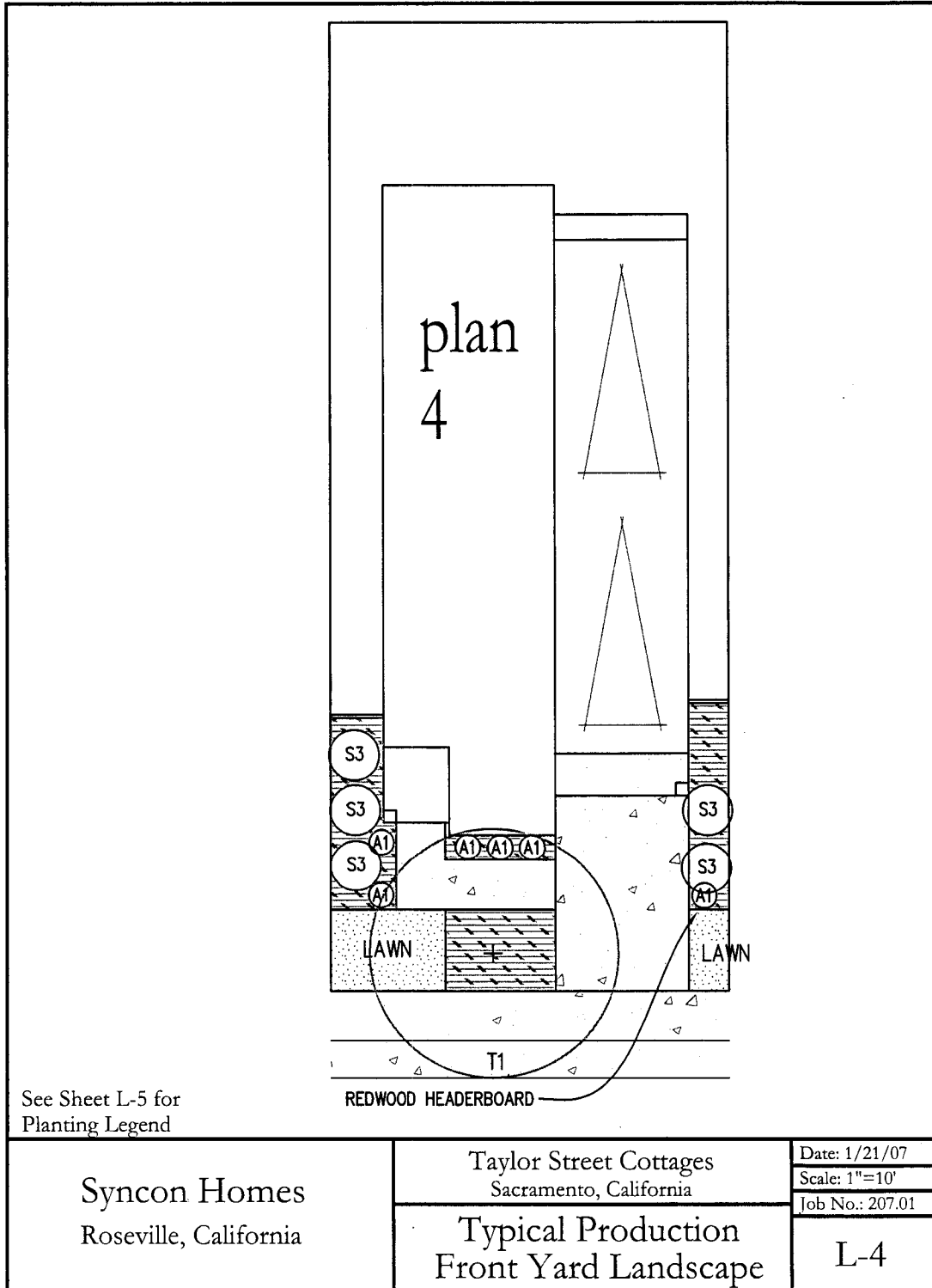

Syncon Homes
Roseville, California

Taylor Street Cottages
Sacramento, California
Typical Production
Front Yard Landscape

Date: 1/21/07
Scale: 1"=10'
Job No.: 207.01
L-4

Attachment 11 – Plan 1 Front Elevations

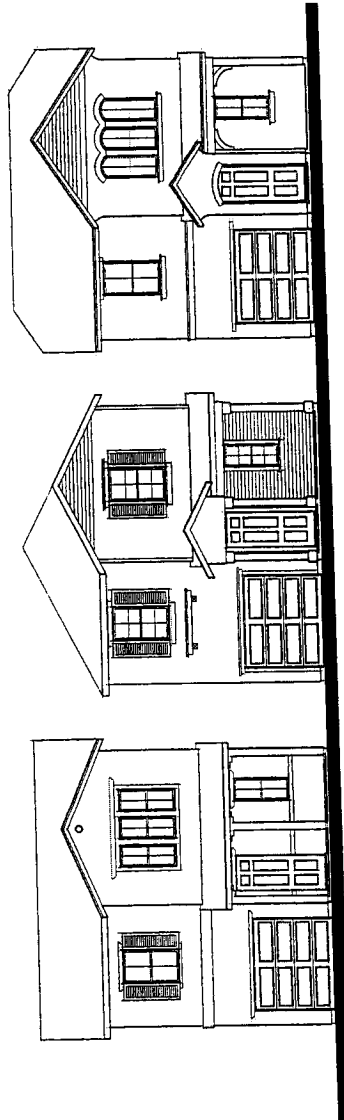

FRENCH

AMERICANA

MONTEREY

PLAN 1

© 2004 JDA/JDA/Associates
Architectural Firm, LLC
07-27-2006

JDA

Taylor Street Cottages
San Clemente, California

Syncon
H O M E S

P06-142

8-11-2006

Attachment 12 – Plan 1 Side/Rear Elevations

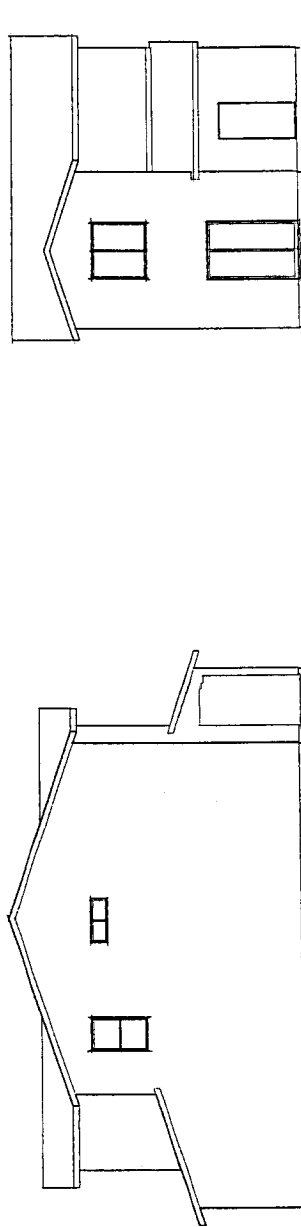

TYPICAL REAR ELEVATION

TYPICAL LEFT ELEVATION

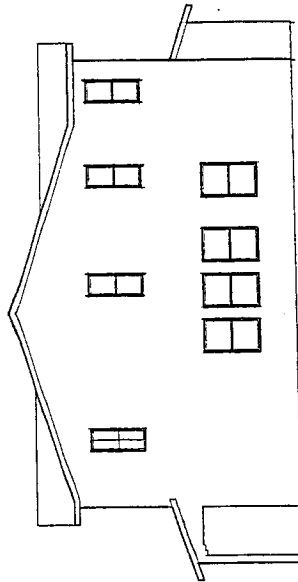

TYPICAL RIGHT ELEVATION

PLAN 1

© 2006 JDA Architects & Planners, Inc.
Architects & Planners, Inc.
07-27-2006

JDA

Taylor Street Cottages
of Sacramento, California

Syncon
HOMES

P06-142

8-11-2006

Attachment 13 – Plan 1 Floorplans

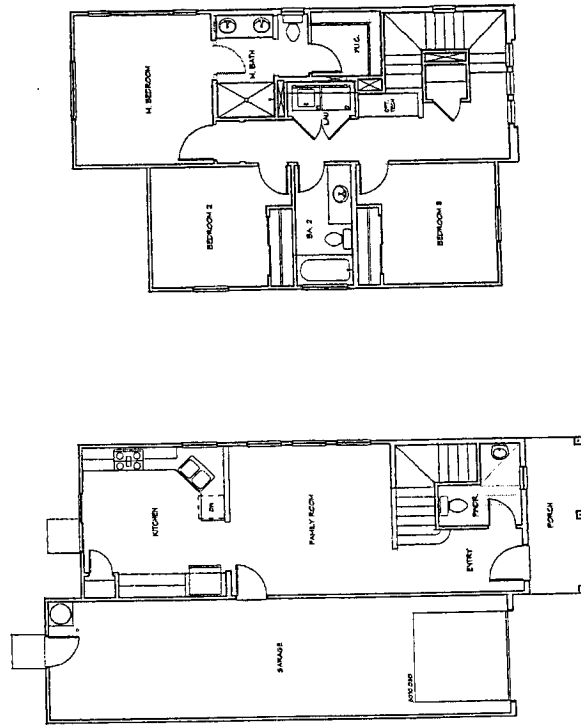

UPPER FLOOR

MAIN FLOOR

PLAN 1 - FLOORPLANS

© 2006 Jeffrey D. Johnson & Associates
Architects, Inc.
DP-27-2006

JDA

Taylor Street Cottages
San Jose, California

P06-142

8-11-2006

Syncon
H O M E S

Attachment 14 – Plan 2 Front Elevations

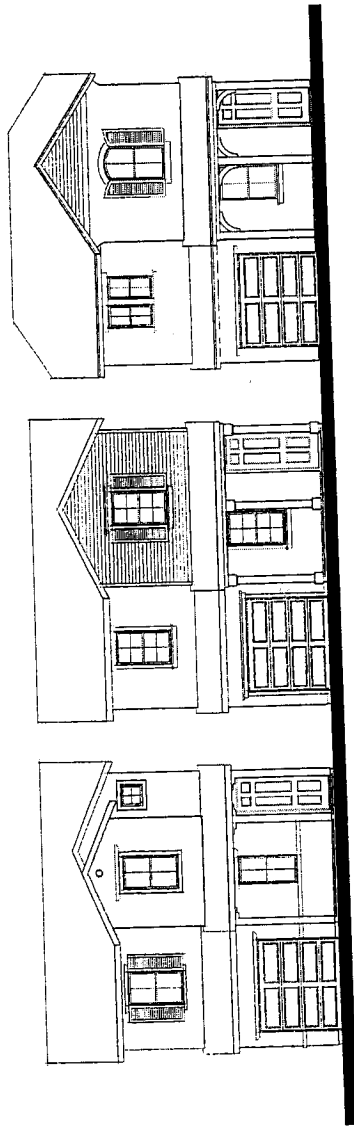

MONTEREY

AMERICANA

FRENCH

PLAN 2

© 2006, Jeffrey D. Baker & Associates
Architects/Planners, Inc.
07-27-2006

JDA

Taylor Street Cottages
San Francisco, California

Syncon
H O U S E S

P06-142
8-11-2006

Attachment 15 – Plan 2 Side/Rear Elevations

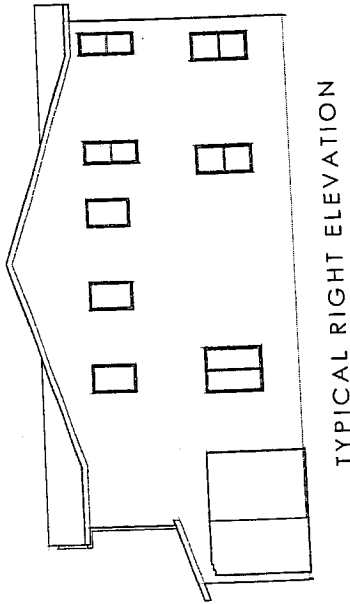
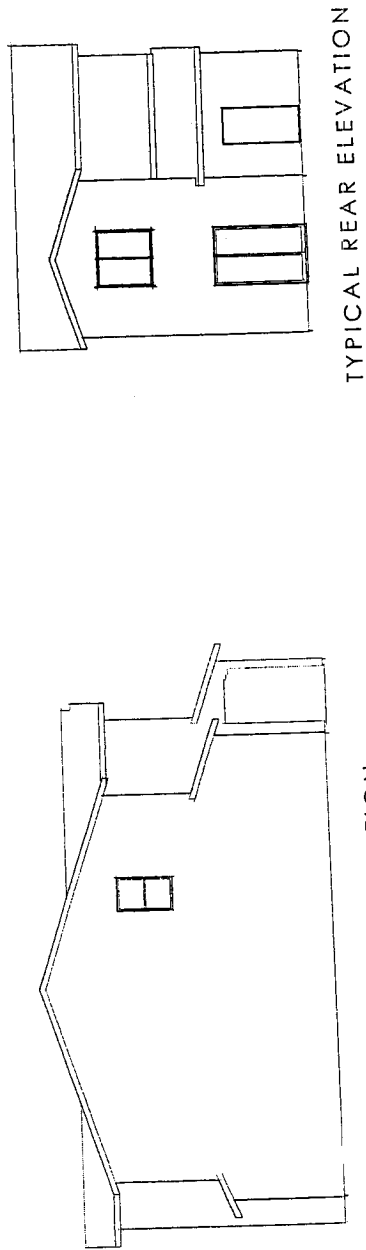

PLAN 2

© 2006, Jeffrey DeRose + Associates
Architects/Planners, Inc.
07-27-2006

JDA

Taylor Street Cottages
Menlo Park, California

Syncon
H O M E S

P06-142

8-11-2006

Attachment 16 – Plan 2 Floorplans

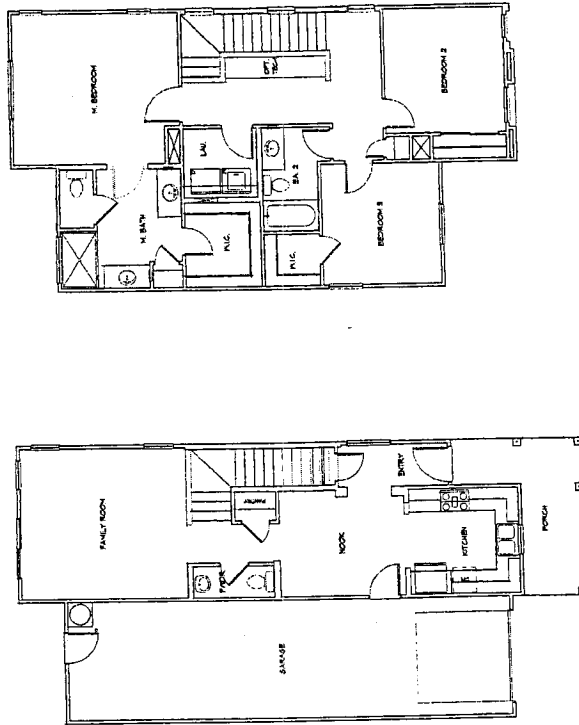

UPPER FLOOR

MAIN FLOOR

PLAN 2 - FLOORPLANS

© 2006 JDA/JDA Architects + Interiors
Architects/Interior Designers, Inc.
07-27-2006

JDA

Taylor Street Cottages
San Francisco, California

P06-142

8-11-2006

Syncon
H O M E S

Attachment 17 – Plan 3 Front Elevations

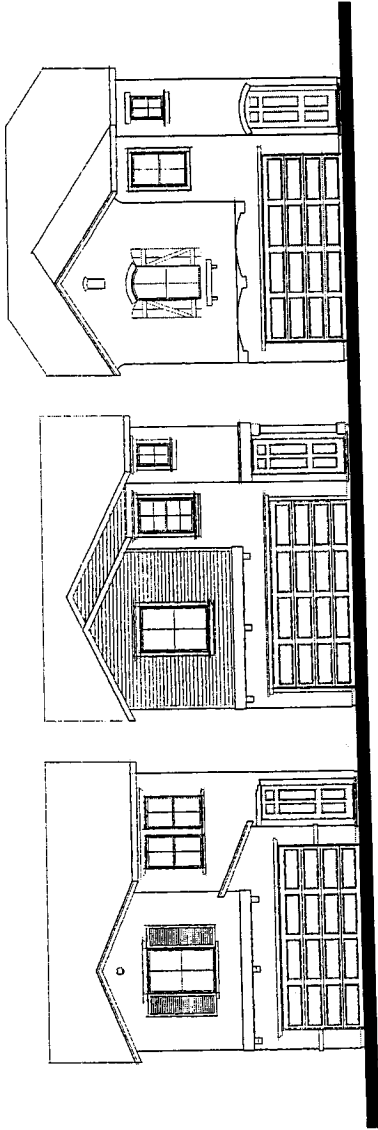

FRENCH

AMERICANA

MONTEREY

PLAN 3

© 2006 JDA/JDA Homes, Inc.
All Rights Reserved. No. 06-07-27-2006

JDA

Taylor Street Cottages
Sacramento, California

Syncon
H O M E S

P06-142
8-11-2006

Attachment 18 – Plan 3 Side/Rear Elevations

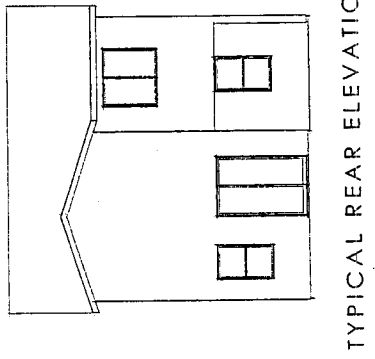
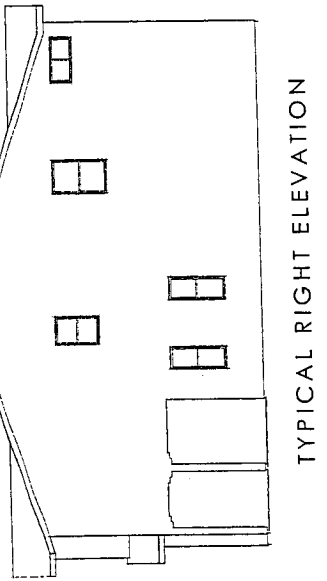
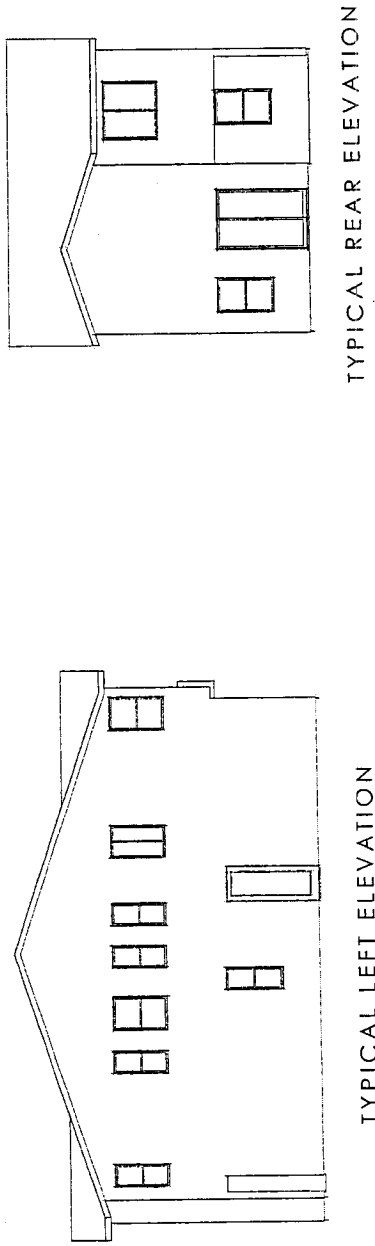

PLAN 3

© 2006 Jeffrey D. Moore, Architect
Architect/Planner, Inc.
07-27-2006

JDA
Taylor Street Cottages
11500 Wilshire Blvd., Suite 1000, Los Angeles, California

Syncon
H O M E S

P06-142
8-11-2006

Attachment 19 – Plan 3 Floorplans

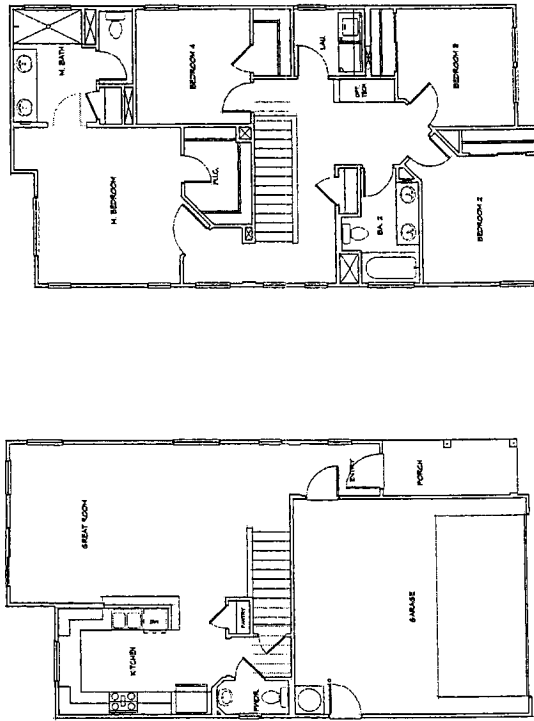

UPPER FLOOR

MAIN FLOOR

PLAN 3 - FLOORPLANS

© 2006 JDA/JDA Architects, Inc.
Architects/Engineers, Inc.
07-27-2006

JDA

Taylor Street Cottages
Sacramento, California

P06-142

8-11-2006

Syncon
IT O M E S

Attachment 20 – Plan 4 Front Elevations

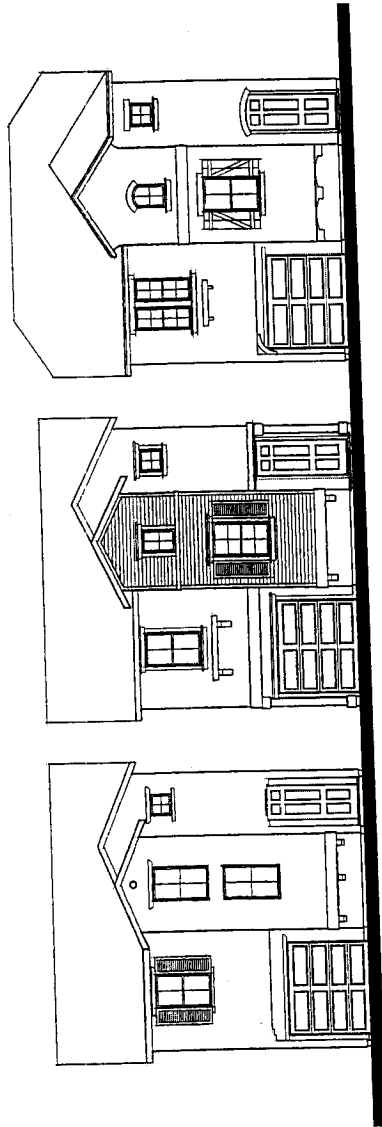

FRENCH

AMERICANA

MONTEREY

PLAN 4

© 2006 JDA/DA Architects + Planners
Architects/Planners, Inc.
07-27-2006

JDA

Taylor Street Cottages
Sacramento, California

P06-142
8-11-2006

Syncon
H O M E S

Attachment 21 – Plan 4 Side/Rear Elevations

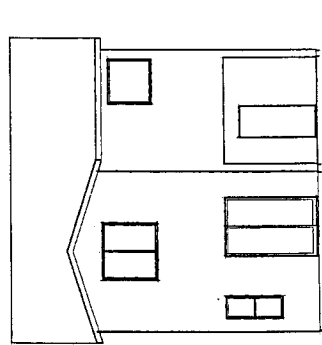

TYPICAL REAR ELEVATION

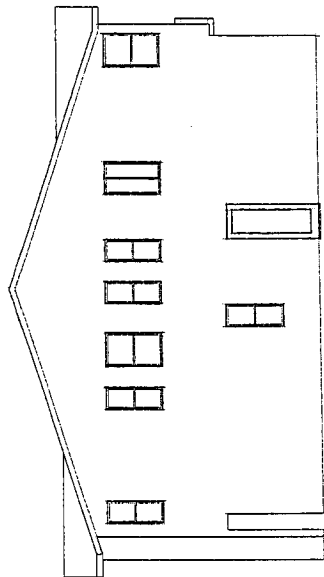

TYPICAL LEFT ELEVATION

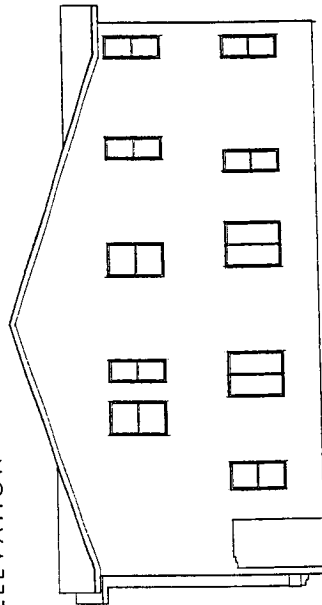

TYPICAL RIGHT ELEVATION

PLAN 4

© 2004 J.D. & Associates - Architects
Architects & Planners, Inc.
07-27-2006

J D & A

Taylor Street Cottages
Sacramento, California

Syncon
H O M E S

P06-142

8-11-2006

Attachment 22 – Plan 4 Floorplans

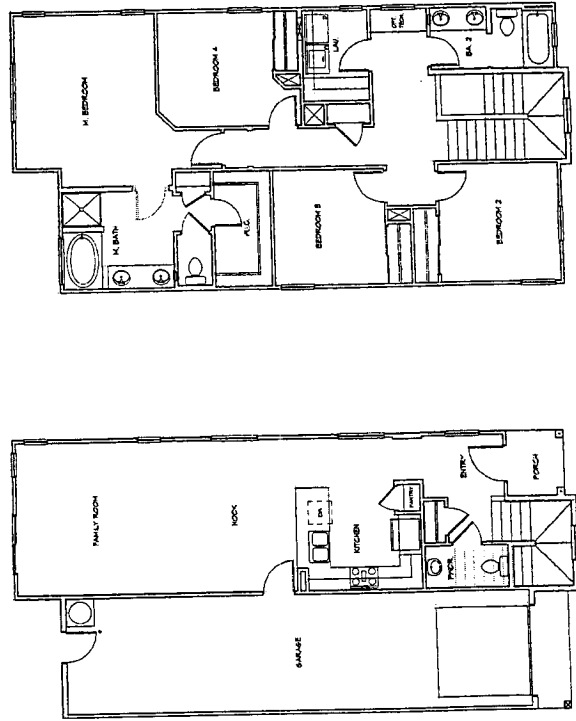

UPPER FLOOR

MAIN FLOOR

PLAN 4 - FLOORPLANS

© 2006 JDA Architects + Planners, Inc.
Architects + Planners, Inc.
07-27-2006

JDA

Taylor Street Cottages
San Clemente, California

P06-142
8-11-2006

Syncon
H O M E S

Attachment 23 – Resolution for Negative Declaration & Mitigation Monitoring Plan

RESOLUTION NO. 2007-

Adopted by the Sacramento City Council

**APPROVING THE MITIGATED NEGATIVE DECLARATION AND THE MITIGATION MONITORING PLAN FOR THE TAYLOR STREET COTTAGES PROJECT, LOCATED ON THE WEST SIDE OF THE 4000 BLOCK OF TAYLOR STREET IN THE NORTH SACRAMENTO COMMUNITY PLAN AREA, SACRAMENTO, CALIFORNIA.
(P06-142) (APN: 237-0180-012 & -053)**

BACKGROUND

A. The City of Sacramento's Environmental Planning Services conducted or caused to be conducted an Initial Study on Taylor Street Cottages, P06-142 ("Project") to determine if the Project may have a significant effect on the environment.

B. The Initial Study identified potentially significant effects of the Project which were agreed to by the applicant before the proposed Mitigated Negative Declaration and Initial Study were released for public review. Mitigation measures were determined by the City's Environmental Planning Services Division to avoid or reduce the potentially significant effects to a less-than-significant level, and, therefore, there was no substantial evidence that the Project as revised and conditioned may have a significant effect on the environment. A Mitigated Negative Declaration (MND) for the Project was then completed, noticed and circulated in accordance with the requirements of the California Environmental Quality Act (CEQA), the State CEQA Guidelines and the Sacramento Local Environmental Procedures as follows:

1. On February 21, 2007 a Notice of Intent (NOI) to adopt the MND dated February 20, 2007 was circulated for public comments for twenty days. The NOI was sent to those public agencies that have jurisdiction by law with respect to the proposed project and to other interested parties and agencies, including property owners within 500 feet of the boundaries of the proposed project. The comments of such persons and agencies were sought during the twenty-day review period.

2. On February 20, 2007 the project site was posted with the NOI, the NOI was published in the Daily Recorder, a newspaper of general circulation, and the NOI was posted in the office of the Sacramento County Clerk.

C. The City Council has reviewed and considered the information contained in the MND, including the Initial Study, the revisions and conditions incorporated into the Project, as well as the hearing of the Project. Comments were received during the public review process from the United States Army Corps of Engineers; however, they

did not affect the findings of the MND. The City Council has determined that the MND constitutes an adequate, accurate, objective and complete review of the environmental effects of the proposed project.

D. The City Council has final approval authority over the following Project entitlement:

1. Rezone 6.79± acres from Agricultural (A) to Single-Family Alternative (R-1A).

E. Pursuant to CEQA Guidelines Section 15091(e), the documents and other materials that constitute the record of proceedings upon which the City Council has based its decision are located in and may be obtained from the Office of the City Clerk at 915 I Street, Sacramento, California. The City Clerk is the custodian of records for all matters before the City Council.

BASED ON THE FACTS SET FORTH IN THE BACKGROUND, THE CITY COUNCIL RESOLVES AS FOLLOWS:

Section 1. Based on its review of the MND and on the basis of the whole record, the City Council finds that the MND reflects the City Council's independent judgment and analysis and that there is no substantial evidence that the Project will have a significant effect on the environment.

Section 2. With respect to the entitlements over which the City Council has final approval authority, the City Council adopts the Mitigated Negative Declaration for the Project.

Section 3. Pursuant to CEQA Guidelines Section 15074, and in support of its approval of the Project, the City Council adopts a Mitigation Monitoring Plan to require that all reasonably feasible mitigation measures be implemented.

Section 4. Upon approval of the Project, the City's Environmental Planning Services Division shall file or cause to be filed a Notice of Determination with the Sacramento County Clerk and, if the project requires a discretionary approval from any state agency, with the State Office of Planning and Research, pursuant to Section 21152(a) of the Public Resources Code and the State Environmental Impact Report Guidelines adopted pursuant thereto.

Table of Contents:

Exhibit A: Mitigation Monitoring Plan – 13 pages

MITIGATION MONITORING PLAN

FOR:

TAYLOR STREET COTTAGES (P06-142)

PREPARED BY:

CITY OF SACRAMENTO
DEVELOPMENT SERVICES DEPARTMENT
ENVIRONMENTAL PLANNING SERVICES
ROCHELLE HALL
808-5914

TYPE OF ENVIRONMENTAL DOCUMENT:

INITIAL STUDY/MITIGATED NEGATIVE DECLARATION

DATE:

February 20, 2007

ADOPTED BY:

CITY OF SACRAMENTO
PLANNING COMMISSION

DATE:

ATTEST:

Exhibit A – Mitigation Monitoring Plan, p. 2

**TAYLOR STREET COTTAGES (P06-142)
MITIGATION MONITORING PLAN**

This Mitigation Monitoring Plan (MMP) has been required by and prepared for the City of Sacramento Development Services Department, Environmental Planning Services, 2101 Arena Blvd., Ste. 200, Sacramento, CA 95834, pursuant to CEQA Guidelines Section 21081.6.

SECTION 1: PROJECT IDENTIFICATION

Project Name/File Number: TAYLOR STREET COTTAGES (P06-142)

Owner/Developer/Applicant: Michael Harlan
Syncon Homes
1508 Eureka Road, Suite 230
Roseville, CA 95661
Phone: (916) 772-5221

City of Sacramento Contact: Rochelle Hall, Assistant Planner
Environmental Planning Services
Development Services Dept
2101 Arena Blvd., Suite 200
Sacramento, CA 95834
Phone: (916) 808-5914

Project Location

The proposed project site is generally rectangular in shape, and is located north of Interstate-80. The site is bounded on the east by Taylor Street. Magpie Creek borders the western boundary of the project site. The project site is located on Assessor's Parcel Numbers (APN) 237-0180-012 and 237-0180-053.

Project Components

The proposed project requests to rezone approximately seven acres from Agricultural (A) to Single-Family Alternative (R-1A) and subdivide the land into 73 single-family lots and four landscape lots. Specific entitlements include:

- A. Inclusionary Housing Plan;**
- B. Rezone** two parcels totaling approximately seven acres from Agricultural (A) to Single-Family Alternative (R-1A) zone;
- C. Special Permit** to allow single-family dwellings in the Single-Family Alternative (R-1A) zone; and
- D. Tentative Parcel Map** to subdivide approximately seven acres to 73 Single-Family lots and four landscape lots in the proposed Single-Family Alternative (R-1A) zone.

Exhibit A – Mitigation Monitoring Plan, p. 3

SECTION 2: GENERAL INFORMATION

The Mitigation Monitoring Plan (MMP) includes mitigation for Biological Resources, Cultural Resources, Hazards, and Noise. The intent of the Plan is to prescribe and enforce a means for properly and successfully implementing the mitigation measures as identified within the Initial Study for this project. Unless otherwise noted, the cost of implementing the mitigation measures as prescribed by this Plan shall be funded by the owner/developer identified above. This Mitigation Monitoring Plan (MMP) is designed to aid the City of Sacramento in its implementation and monitoring of mitigation measures adopted for the proposed project.

The mitigation measures have been taken verbatim from the Initial Study and are assigned the same number they have in the document. The MMP describes the actions that must take place to implement each mitigation measure, the timing of those actions, and the entities responsible for implementing and monitoring the actions. The developer will be responsible for fully understanding and effectively implementing the mitigation measures contained within the MMP. The City of Sacramento, along with other applicable local, state or federal agencies, will be responsible for ensuring compliance.

MITIGATION AGREEMENT

PROJECT NAME / FILE NUMBER: Taylor Street Cottages (P06-142)

OWNER/DEVELOPER/APPLICANT: Michael Harlan
Syncon Homes
1508 Eureka Road, Suite 230
Roseville, CA 95661
Phone: (916) 772-5221

I, Michael Harlan (owner/developer/applicant), agree to amend the project application P06-142 to incorporate the attached mitigation measures as identified in the Initial Study for the project. I understand that by agreeing to these mitigation measures, all identified potentially significant environmental impacts should be reduced to below a level of significance, thereby enabling the Environmental Coordinator to prepare a Mitigated Negative Declaration of environmental impact for the above referenced project.

I also understand that the City of Sacramento will adopt a Mitigation Monitoring Plan (Plan) for this project. This Plan will be prepared by the Development Services Department, pursuant to the California Environmental Quality Act Guidelines Section 21081.6 and pursuant to Article III of the City's Local Administrative Procedures for the Preparation of Environmental Documents.

I acknowledge that this project, P06-142, would be subject to this Plan at the time the Plan is adopted. This Plan will establish responsibilities for the monitoring of my project by various City Departments and by other public agencies under the terms of the agreed upon mitigation measures. I understand that the mitigation measures adopted for my project may require the expenditure of owner/developer funds where necessary to comply with the provisions of said mitigation measures.



Signature (Owner/Developer/Applicant)

Director of Land Acquisition
Title

3.21.07
Date

Exhibit A – Mitigation Monitoring Plan, p. 5

**TAYLOR STREET COTTAGES (P06-142)
MITIGATION MONITORING PLAN**

		VERIFICATION OF COMPLIANCE		
MITIGATION MEASURE	IMPLEMENTING RESPONSIBILITY	MONITORING RESPONSIBILITY	COMPLIANCE STANDARDS	TIMING
				VERIFICATION OF COMPLIANCE (INITIALS/DATE)
<p>Biological Resources: BR-1a Prior to issuance of grading permits, the applicant shall retain a qualified biologist to conduct preconstruction surveys of suitable burrowing owl habitat within the project site within 30 days prior to construction to ensure that no burrowing owls have become established at the site. If ground disturbing activities are delayed or suspended for more than 30 days after the preconstruction survey, the site shall be re-surveyed. If no burrowing owls are located, then no further mitigation is required.</p> <p>BR-1b If located, occupied burrows shall not be disturbed during the nesting season (February 1 through August 31) unless a qualified biologist approved by California Department of Fish and Game (CDFG) verifies through noninvasive methods that either the birds have not begun egg-laying and incubation; or that juveniles from the occupied burrows are foraging independently and are capable of independent survival.</p>	Applicant	City of Sacramento – Development Services Department and California Department of Fish and Game	Measures shall be included on all grading and construction plans	Measures shall be implemented prior to the issuance of grading permits and during construction activities, as specified.

**TAYLOR STREET COTTAGES (P06-142)
MITIGATION MONITORING PLAN**

<p>BR-1c If destruction of occupied burrows is unavoidable, the applicant shall coordinate with CDFG to identify existing suitable burrows located on protected land to be enhanced or new burrows will be created by installing artificial burrows at a ratio of 2:1.</p>				
<p>BR-1d If owls must be relocated away from the site the applicant shall coordinate with CDFG to relocate the owls using passive relocation techniques (as described in the CDFG's October 17, 1995, Staff Report on burrowing owl mitigation, or latest version).</p>				
<p>BR-1e If avoidance is the preferred method of mitigating potential project impacts, then no disturbance shall occur within 160 feet of occupied burrows during the non-breeding season (September 1 through January 31) or within 250 feet during the breeding season (February 1 through August 31).</p>				
<p>BR-2 The applicant shall clearly mark the boundary of the seasonal wetland area identified in the Preliminary Jurisdictional Delineation Report (Report) for the project site (Sycamore, 2007). The area shall be avoided during project construction</p>				

Exhibit A – Mitigation Monitoring Plan, p. 7

**TAYLOR STREET COTTAGES (P06-142)
MITIGATION MONITORING PLAN**

<p>and operation. In the event the United States Army Corps of Engineers verifies the Report, the use restrictions on such area set forth in this Mitigation Measure shall lapse and be of no further effect. In the event the USACE determines that such area is a jurisdictional wetland, the applicant shall comply with all requirements applicable to the area as established by the USACE. Any fill of such area shall comply with the "Isolated Wetlands Waste Discharge Requirement" issued by the Regional Water Quality Control Board.</p> <p>Cultural Resources: CR-1a In the event that any prehistoric subsurface archeological features or deposits, including locally darkened soil ("midden"), that could conceal cultural deposits, animal bone, obsidian and/or mortars are discovered during construction-related earth-moving activities, all work within 50 meters of the resources shall be halted, and the City shall consult with a qualified archeologist to assess the significance of the find. Archeological test excavations shall be conducted by a qualified archeologist to aid in determining the nature and integrity of the find. If the find is determined to be significant by</p>	<p>Applicant</p>	<p>City of Sacramento— Development Services Department and Native American Heritage Commission</p>	<p>Measures shall be included on all grading and construction plans</p>	<p>Measures shall be implemented during construction activities, as specified.</p>	
--	------------------	--	---	--	--

Exhibit A – Mitigation Monitoring Plan, p. 8

**TAYLOR STREET COTTAGES (P06-142)
MITIGATION MONITORING PLAN**

<p>the qualified archeologist, representatives of the City and the qualified archeologist shall coordinate to determine the appropriate course of action. All significant cultural materials recovered shall be subject to scientific analysis and professional museum curation. In addition, a report shall be prepared by the qualified archeologist according to current professional standards.</p> <p>CR-1b If a Native American site is discovered, the evaluation process shall include consultation with the appropriate Native American representatives.</p> <p>If Native American archeological, ethnographic, or spiritual resources are involved, all identification and treatment shall be conducted by qualified archeologists, who are certified by the Society of Professional Archeologists (SOPA) and/or meet the federal standards as stated in the Code of Federal Regulations (36 CFR 61), and Native American representatives, who are approved by the local Native American community as scholars of the cultural traditions.</p> <p>In the event that no such Native American is available, persons who</p>					
--	--	--	--	--	--

Exhibit A – Mitigation Monitoring Plan, p. 9

**TAYLOR STREET COTTAGES (P06-142)
MITIGATION MONITORING PLAN**

<p>represent tribal governments and/or organizations in the locale in which resources could be affected shall be consulted. If historic archeological sites are involved, all identified treatment is to be carried out by qualified historical archeologists, who shall meet either Register of Professional Archeologists (RPA), or 36 CFR 61 requirements.</p> <p>CR-2 If a human bone or bone of unknown origin is found during construction, all work shall stop in the vicinity of the find, and the County Coroner shall be contacted immediately. If the remains are determined to be Native American, the coroner shall notify the Native American Heritage Commission, who shall notify the person most likely believed to be a descendant. The most likely descendant shall work with the contractor to develop a program for re-interment of the human remains and any associated artifacts. No additional work is to take place within the immediate vicinity of the find until the identified appropriate actions have taken place.</p> <p>Energy E-1 Connection to an existing natural gas line or installation of a natural gas line in a location other than a public</p>	<p>Applicant</p>	<p>City of Sacramento – Department of Development Services</p>	<p>Measures shall be included on all grading and construction plans</p>	<p>Prior to issuance of Grading Permit</p>
---	------------------	--	---	--

Exhibit A – Mitigation Monitoring Plan, p. 10

**TAYLOR STREET COTTAGES (P06-142)
MITIGATION MONITORING PLAN**

<p>right-of-way would require further environmental review by the City of Sacramento Environmental Planning Services division prior to the issuance of grading or construction permits by the City of Sacramento.</p> <p>Hazards HZ-1 The 55-gallon "Chevron 15w-40 Oil" drum and its contents shall be removed from the project site and disposed of in accordance with local and state regulations. The oil drum and its contents shall be taken to a household hazardous waste collection facility or a licensed oil collection site. Such a facility and site may be found by contacting the CALEPA Hotline at 1-800-CLEANUP or online at www.1800cleanup.org. The applicant shall retain a receipt from the hazardous waste facility or oil collection site and present it to City of Sacramento Development Services Department.</p> <p>HZ-2 The general household material, including a waste oil filter, shall be removed from the project site, and its source shall be eliminated. These household materials shall be taken to a household hazardous waste collection facility, and may be found by contacting the CALEPA Hotline at 1-800-CLEANUP or online at</p>	<p>Applicant</p>	<p>City of Sacramento – Department of Development Services, California Department of Toxic Substance Control</p>	<p>Measures shall be included on all grading and construction plans</p>	<p>Prior to issuance of Grading Permit</p>	
--	------------------	--	---	--	--

Exhibit A – Mitigation Monitoring Plan, p. 11

**TAYLOR STREET COTTAGES (P06-142)
MITIGATION MONITORING PLAN**

<p>www.1800cleanup.org. The applicant shall retain a receipt from the hazardous waste facility or oil collection site and present it to City of Sacramento Development Services Department.</p> <p>HZ-3 The pieces of asbestos-cement piping material and asbestos contaminated soil shall be collected and properly disposed of by a licensed asbestos abatement contractor prior to any disturbance and development of the project site. A licensed asbestos abatement contractor and may be found by contacting the CALEPA Hotline at 1-800-CLEANUP or online at www.1800cleanup.org. The applicant shall retain a receipt from the asbestos abatement contractor and present it to City of Sacramento Development Services Department.</p> <p>Hydrology H-1 The applicant shall submit an application for a Letter of Map Change (LOMC) to FEMA through the City of Sacramento. A Letter of Map Revision (LOMR) shall be sent to the City of Sacramento Department of Utilities for approval prior to the recordation of the final map and issuance of any construction permits. If the LOMR is not approved by the</p>	<p>Applicant</p>	<p>City of Sacramento – Department of Utilities</p>	<p>Measure shall be included on all construction plans</p>	<p>Prior to the recordation of the final map and issuance of any grading or construction permits</p>	
--	------------------	---	--	--	--

Exhibit A – Mitigation Monitoring Plan, p. 12

**TAYLOR STREET COTTAGES (P06-142)
MITIGATION MONITORING PLAN**

<p>City of Sacramento Department of Utilities, no construction permits shall be issued for development in the AE Flood Zone.</p> <p>Noise The following noise mitigation measures, N-1a, N-1b, N-1c, and N-1d are required to achieve the City of Sacramento 60 dB Ldn exterior noise level criterion.</p> <p>N-1a Prior to issuance of occupancy permits, a traffic noise barrier wall shall be constructed along the south property line. The wall shall be 11 feet in height, join the existing wall, continue to the property corner, and continue to the property corner, then continue along the entire westerly property boundary. The noise barrier shall step down linearly along the western property line, gradually decreasing in height to reach 6-feet at the north property line.</p> <p>N-1b Prior to issuance of occupancy permits, a traffic noise barrier wall shall be constructed along the westerly right-of-way of Taylor Street. The wall shall be 8 feet in height.</p> <p>N-1c All barrier heights are relative to the</p>	<p>Applicant</p>	<p>City of Sacramento – Department of Development Services</p>	<p>Construction plans shall incorporate the applicable noise attenuation measure and be approved by the Building Division.</p>	<p>Prior to issuance of any Final Building Permits, Certificate of Occupancy</p>	
--	------------------	--	--	--	--

Exhibit A – Mitigation Monitoring Plan, p. 13

**TAYLOR STREET COTTAGES (P06-142)
MITIGATION MONITORING PLAN**

<p>building pad elevation.</p> <p>N-1d Noise Barriers shall be constructed of concrete or masonry block, precast concrete, earthen berm, or any combination.</p> <p>The following mitigation measures N-2a, N-2b are required to achieve the City of Sacramento noise level standard of 45 dB Ldn interior noise level criterion.</p> <p>N-2a All second floor facades, backing Interstate 80 with line of site to that roadway, shall be constructed of stucco siding and all second floor windows of those units from which Interstate 80 is visible shall have a minimum STC-32 rating. The STC-32 rating shall be inspected by a City of Sacramento Building Inspector prior to issuance of a framing permit.</p> <p>N-2b Air conditioning shall be included in all residences, to allow occupants to close doors and windows.</p>					
---	--	--	--	--	--

Attachment 24 – Resolution for Inclusionary Housing Plan

RESOLUTION NO. 2007-

Adopted by the Sacramento City Council

ADOPTING THE INCLUSIONARY HOUSING PLAN FOR THE TAYLOR STREET COTTAGES PROJECT LOCATED ON THE WEST SIDE OF THE 4000 BLOCK OF TAYLOR STREET IN THE NORTH SACRAMENTO COMMUNITY PLAN AREA, SACRAMENTO, CALIFORNIA. (P06-142) (APN: 237-0180-012 AND -053)

BACKGROUND

The City Council conducted a public hearing on Thursday, April 26, 2007 concerning the Inclusionary Housing Plan, and, based on documentary and oral evidence submitted at the public hearing, the City Council hereby finds:

- A. The proposed project is located in a new growth area and is subject to the City's mixed income housing requirements that 15 percent of the residential units be affordable to "Low" and "Very Low" income households; and
- B. The proposed plan is consistent with Chapter 17.190 of the City Code which requires an Inclusionary Housing Plan setting forth the number, unit mix, location, structure type, affordability and phasing of the inclusionary units in the residential development.

BASED ON THE FACTS SET FORTH IN THE BACKGROUND, THE CITY COUNCIL RESOLVES AS FOLLOWS:

Section 1. The Inclusionary Housing Plan for the Taylor Street Cottages Project (P06-142) is hereby adopted as attached hereto as Exhibit A.

Table of Contents:

Exhibit A: Inclusionary Housing Plan – 6 Pages

Exhibit A – Inclusionary Housing Plan, p. 1

INCLUSIONARY HOUSING PLAN
Taylor Street Cottages
March 22, 2007

Proposed Project

SMV Sacramento Land, LP is the owner and Syncon Homes of California is the developer (the “Developer”) of that certain real property in the City of Sacramento in which the Developer proposes to develop and construct the Taylor Street Cottages (“Project”). This 6.9 +/- acre (gross) Project is located north of Interstate 80 and south of Jessie Avenue, between Norwood Avenue and Taylor Street. The Project consists of an exclusively single family development including 73 single family home sites.

Mixed Income Housing Policy

The Project site is located in a new growth area and the project is subject to the City’s Mixed Income Housing Policy. The Mixed Income Housing Policy adopted in the City of Sacramento Housing Element and required by the City’s Mixed Income Housing Ordinance, City of Sacramento City Code Chapter 17.190, requires that ten percent (10%) of the total units in a Residential Project be affordable to very low income households and five percent (5%) to low income households (the “Inclusionary Requirement” and “Inclusionary Units”).

Pursuant to the City Code Section 17.190.110 (B), an Inclusionary Housing Plan (“Plan”) must be approved prior to or concurrent with the approval of legislative or adjudicative entitlements for the Project. City Code Section 17.190.110 (A) sets forth the number, unit mix, location, structure type, affordability and phasing of the Inclusionary Units in the Project. This document constitutes that Plan, and, as supplemented and amended from time to time, is intended to begin implementation of the Inclusionary Requirement. All future approvals for the Project, including tentative maps, subsequent tentative maps, planned development permits, special permits, site development plans, and plan review shall be consistent with this Inclusionary Housing Plan.

The Inclusionary Requirement for the Residential Project will be set forth in more detail in the Inclusionary Housing Agreement executed by the Developer and the Sacramento Housing and Redevelopment Agency (“SHRA”) and recorded against all the residential land in the Project. The Inclusionary Housing Agreement shall be executed prior to the approval of the final map for the subdivision and recorded concurrently with the recordation of the final map. The Inclusionary Housing Agreement will describe with particularity the site and building schematics of the Inclusionary Units and the phasing requirements linking the affordable and market rate units, pursuant to Section 17.90.110.C. The Inclusionary Housing Agreement shall be consistent with this Plan.

Exhibit A – Inclusionary Housing Plan, p. 2

Number of Inclusionary Units

The Developer, or its successors and assignees, shall construct or cause to be constructed a number of dwelling units affordable to Very Low Income Households (“Very Low Income Units”) and Low Income Households (“Low Income Units”) as defined in the Sacramento City Code Section 17.190.020, equal to ten percent (10%) and five percent (5%) of the total number of housing units approved for the Residential Project, respectively. Based on the current Project proposal, the Inclusionary Requirement for the Project is seven (7) Very Low Income Units (10%) and four (4) Low Income Units (5%).

Table 1

Total Number of Units within the Project	73
Very Low Income Units (10% of units)	7
Low Income Units (5% of units)	4
Total Number of Inclusionary Units	11

If the Project approvals are amended to increase the number of units in the Project, this Plan will be amended to reflect an increase equal to ten percent (10%) of the increased total residential units in the amended entitlements for Very Low Income units and five percent (5%) for Low Income units. If the Project approvals are amended to decrease the number of residential units in the Project, this Plan will be amended to reflect a decrease equal to ten percent (10%) of the decreased total residential units in the amended entitlements for Very Low Income units and five percent (5%) for Low Income units. However, after a building permit has been issued for a structure that contains Inclusionary Units, those Units will be constructed and maintained as Inclusionary Units pursuant to the terms of Chapter 17.190 of the City Code regardless of any subsequent reduction in the number of approved total residential units in the Project.

Units by Type and Tenure

The Inclusionary Housing Units shall consist of 11 single family units. Developer will offer the units as ownership units. An initial owner who purchases a for-sale Inclusionary Unit shall occupy that unit as his/her principal residence and shall certify to SHRA that he/she is a first time home buyer. SHRA will record a regulatory agreement against each Inclusionary Unit, detailing the recapture difference between the market sales price and the affordable price (adjusted for inflation) if the home is resold to a non-income qualified buyer in the future.

Exhibit A – Inclusionary Housing Plan, p. 3

Size and Bedroom Count

The Inclusionary Housing units shall include three-bedroom and four bedrooms units to accommodate diverse family sizes. The precise bedroom mix and unit size are as follows:

Table 2

Model (sq ft.)	#of Bedrooms	Units Planned	Inclusionary Units	Type of Unit
1346	3	16	7	Very Low Income
1346	3	2	2	Low Income
1456	4	2	2	Low Income
1459	3	19	0	
1652	4	19	0	
1764	4	19	0	
Total		73	11	

Location of Inclusionary Units Within the Project

The Inclusionary Units shall be located throughout the Development Project consistent with the specific lot designations identified in Table 3 and shown in Attachment 1.

Table 3

Size of Unit	Number of Units	Level of Affordability	Lot Number
1346 sq ft	7	Very Low Income	6, 23, 35, 57, 63, 68, 73
1346 sq ft	2	Low Income	11, 29
1456sq ft	2	Low Income	1, 15

The locations of the Inclusionary Units within the Project are subject to Amendment, consistent with Section 17.190.110 B(3)(d) of the Mixed Income Ordinance.

Marketing of Units

The Developer shall be required to market Inclusionary Units in the same manner as non-Inclusionary Units. Such marketing activities may include newspaper and internet advertisements, toll free project information numbers, and on- or off-site project signage. In addition, the Developer shall make Inclusionary Housing information available in the on-site sales office.

Affordability Requirements

Sale and occupancy of the Inclusionary Units shall be restricted to households with incomes, at the time of initial occupancy, that do not exceed fifty percent (50%) of the median income for Sacramento County, adjusted for actual household size, for Very Low Income households and eighty percent (80%) of the median income for Low Income households and shall be consistent with the SHRA guidelines. Median income figures

Exhibit A – Inclusionary Housing Plan, p. 4

are those published annually by the United States Department of Housing and Urban Development.

The sale price of the units will be set so that low income and very low income households can qualify for the purchase of the Inclusionary Units. The sales price will be set such that no more than thirty-five percent (35%) of the gross annual household income of the given income group will be allocated to housing costs. As part of the Inclusionary Housing Agreement, SHRA will provide the Developer with a schedule of maximum sales prices affordable to income ranges.

Sales prices of units will be outlined in the Inclusionary Housing Agreement. The units will be sold initially at an affordable housing price to a low or very low income household with a first time home buyer. An SHRA 30-year note will govern the home's resale, allowing SHRA ninety days to refer an income-eligible buyer after notification of the owner's intent to sell. If an income-eligible purchaser is not found, the home may be resold, provided that SHRA recaptures the difference between the home's market value and its affordable housing price as well as any other City or SHRA contributions. The owner occupant will receive his or her initial equity in the home and a portion of the home's appreciated value. The terms of this arrangement will be outlined in the Inclusionary Housing Agreement between SHRA and the Developer. The process by which the for-sale units are to be priced, sold and monitored are detailed in the "Guidelines for the Sale of Inclusionary Housing", adopted by the City Council on April 29, 2004.

Phasing of Development of the Inclusionary Units

The Inclusionary Units shall be developed concurrently with the development of the remaining units in the Project, as defined in Sacramento City Code Section 17.190.020. The nature of the concurrency is defined by a series of linkages between approvals of the market rate units and the development of the Inclusionary Units.

Market Rate Housing/Inclusionary Unit Linkages

The following describes the relationship of market rate development activity to Inclusionary Unit development activity. These milestones are outlined to ensure that the development of affordable units occurs concurrent with development of market rate units:

- The Inclusionary Housing Plan shall be approved concurrently with the approval of the Project's tentative map.
- The Inclusionary Housing Agreement shall be executed prior to approval of the Project's final map.
- The Inclusionary Housing Agreement shall be recorded concurrently with the recordation of the Project's final map.

Exhibit A – Inclusionary Housing Plan, p. 5

- Up to 65% of the building permits for market rate residential units may be issued prior to the issuance of building permits for all inclusionary units in the subdivision.
- Marketing of inclusionary units within the Project shall occur concurrently with the marketing of market rate units.

Amendment and Administration of the Inclusionary Housing Plan

The Planning Director, with the advice of the Executive Director of SHRA, shall administer this Inclusionary Housing Plan. The Planning Director may make minor administrative amendments to the text of this Plan as provided in Sacramento City Code Section 17.190.110B(3)(d).

Exhibit A – Inclusionary Housing Plan, p. 6

EXHIBIT 1

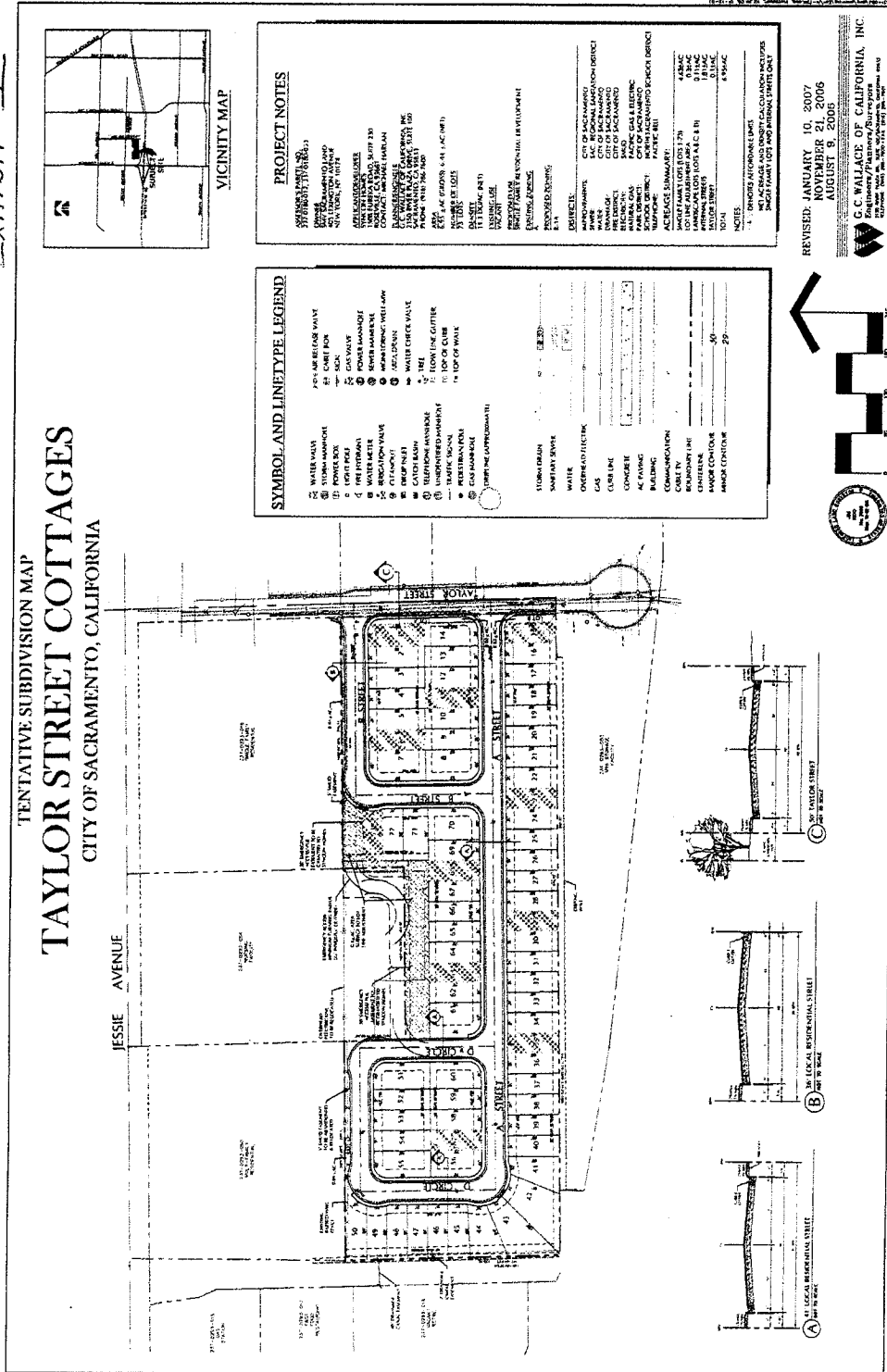

ORDINANCE NO. 2007-
ADOPTED BY THE SACRAMENTO CITY COUNCIL

AMENDING THE DISTRICTS ESTABLISHED BY THE COMPREHENSIVE ZONING ORDINANCE NO. 99-015, AS AMENDED, BY REZONING A PORTION OF THE LAND LOCATED ON THE WEST SIDE OF THE 4000 BLOCK OF TAYLOR STREET FROM AGRICULTURAL (A) TO SINGLE-FAMILY ALTERNATIVE (R-1A).

(P06-142) (APN: 237-0180-012 & 238-0180-053)

BE IT ENACTED BY THE COUNCIL OF THE CITY OF SACRAMENTO:

SECTION 1

The property generally described, known, and referred to as Taylor Street Cottages (APN: 237-0180-012 & 237-0180-053) which is shown on Exhibit A, consists of 6.79± acres currently located in the Agricultural (A) Zone established by the Comprehensive Zoning Ordinance (Title 17 of the City Code). Said property is hereby removed from the Agricultural (A) Zone and placed in the Single-Family Alternative (R-1A) Zone.

SECTION 2

Rezoning of the property described in the attached Exhibit A by the adoption of this Ordinance shall be deemed to be in compliance with the procedures for the rezoning of property described in the Comprehensive Zoning Ordinance, Title 17 of the City Code.

SECTION 3

The City Clerk of the City of Sacramento is hereby directed to amend the official zoning map, which is a part of said Comprehensive Zoning Ordinance, Title 17 of the City Code, to conform to the provisions of this Ordinance.

Table of Contents:

Exhibit A – Rezone Exhibit

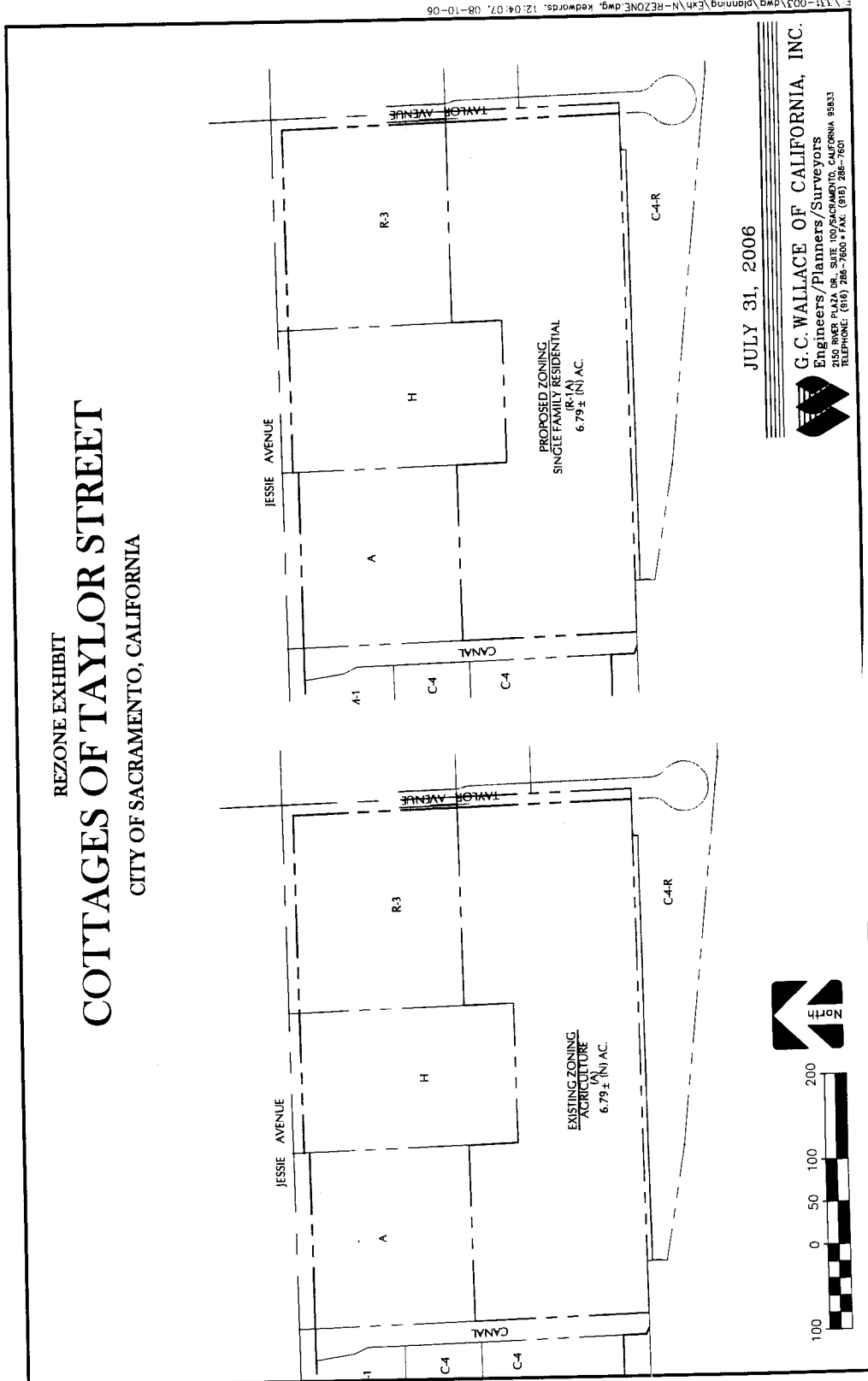

P06-142
8-11-2006